

10003
Ilmenite Basalt (low K)
213 grams



Figure 1: Photo of 10003,25. Sample is 5 cm across. NASA S76-25545.

Introduction

Lunar sample 10003 is a low-K, high-Ti basalt (figure 1). It is about 3.9 b.y. old, with a cosmic ray exposure age of 137 m.y. Its location on the lunar surface was not recorded. It was returned in ALSRC #1004, and was one of the first lunar samples studied.

Petrography

Schmitt et al. (1970) termed 10003 a “medium-grained, vuggy subophitic basalt” while Beatty and Albee (1978) and Gamble et al. (1978) described the texture as “ophitic”. McGee et al. (1977) described sample 10003 as a “medium-grained porphyritic pyroxene basalt characterized by anhedral phenocrysts of pyroxene (1.0 – 2.7mm) set in a subophitic matrix of plagioclase,

pyroxene and ilmenite” (figure 2). The mesostasis includes cristobalite, K-rich glass, troilite with metallic iron blebs, and small amount of pore space. Tablet-shaped plagioclase (0.1 – 0.6mm) occurs both subophitically intergrown with pyroxene phenocrysts and as an interstitial phase between phenocrysts. Ilmenite typically occurs as blocky, irregularly shaped bodies (0.5 – 1.0mm) intergrown with pyroxene and plagioclase, and as inclusions in pyroxene phenocrysts.

Mineralogy

Olivine: Olivine cores are found in some pyroxene (Beatty and Albee 1978).

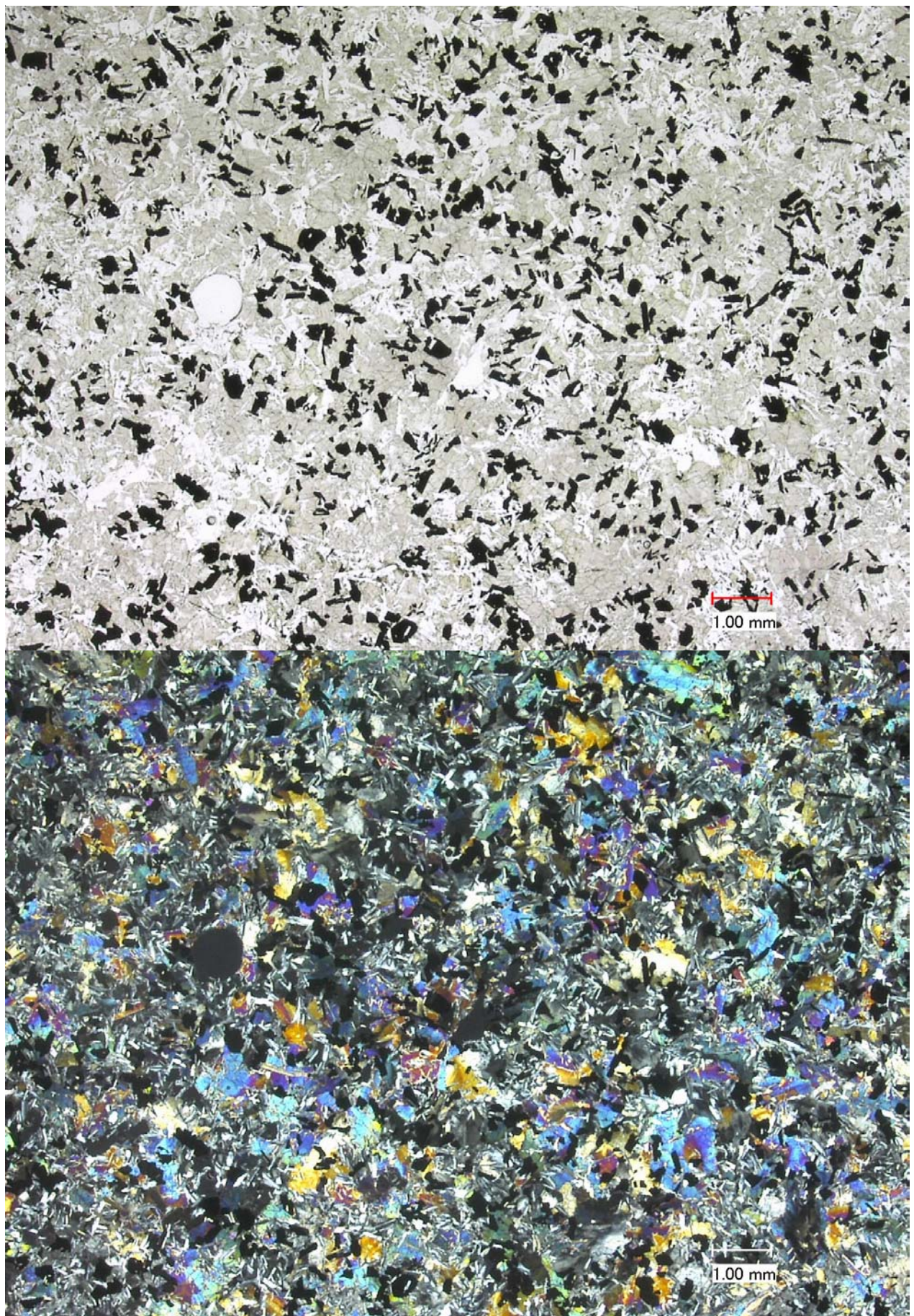



Figure 2: Photomicrographs of thin section 10003,37 (plane polarized and crossed polarized). Width is 2.6 mm. NASA S70-49473-49474.

Pyroxene: Hafner and Virgo (1970), Beatty and Albee (1978) and Gamble et al. (1978) determined pyroxene composition of 10003 (figure 3). Single crystal X-ray diffraction studies show that the pyroxene is an intergrowth of pigeonite and augite (Ross et al. 1970). The distribution of cations in pyroxene sites was studied by Hafner and Virgo. They determined that there was no Fe^{+3} .

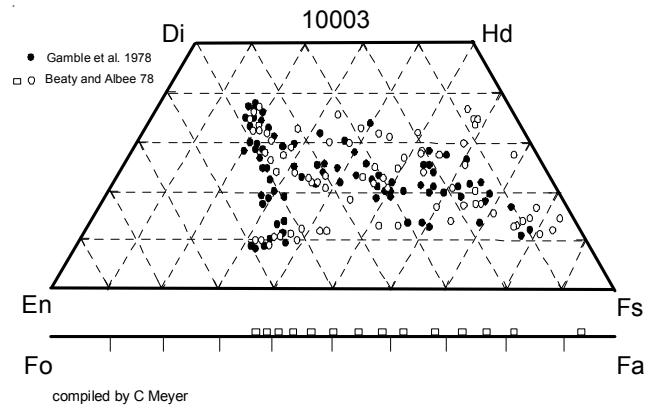

Figure 3: Pyroxene and olivine composition of 10003 (replotted from Beatty and Albee 1978 and Gamble et al. 1978).

Plagioclase: The chemical composition of plagioclase was found to be zoned from An_{93} to An_{67} by Beatty and Albee (1978). The composition of plagioclase (An_{85}) can also be estimated from the crystallographic data by Stewart et al. (1970).

Ilmenite: Gamble et al. (1978) describe the ilmenite in 10003 as elongate and euhedral. They found some grains were low in Mg, while others were high in Mg (up to 6.3% MgO). Stewart et al. (1970) determined the crystallographic data for ilmenite in 10003.

Rutile: Haggerty et al. (1970) studied the nature of rutile inclusions in ilmenite host in 10003.

Chemistry

The K and Rb content of 10003 is low while REE content is intermediate compared with other Apollo 11 basalts (figure 5). The modern analysis by Rhodes and Blanchard (1980) confirmed earlier work. The recent trace-element analysis reported by Neal (2001) is probably superior.

Mineralogical Mode for 10003

	James and Jackson 70	Beatty and Albee 1978	Haggerty et al. 1970	Gamble et al. 1978	Bailey et al. 1970
Olivine	0.5	0.52			tr.
Pyroxene	48.7	50	51.7	48.6	50
Plagioclase	34.8	34.2	29	33.5	33.8
Ilmenite	14.1	13.3	18.2	14.9	14
mesostasis				0.8	
silica	1	1.06	0.3	1.4	1.2
troilite	0.5	0.68		0.8	
phosphate	0.2	0.25			

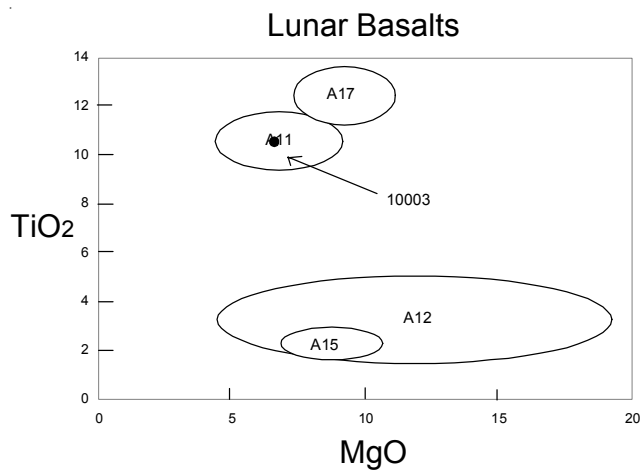

Figure 4: Composition of 10003 compared with that of other Apollo lunar samples.

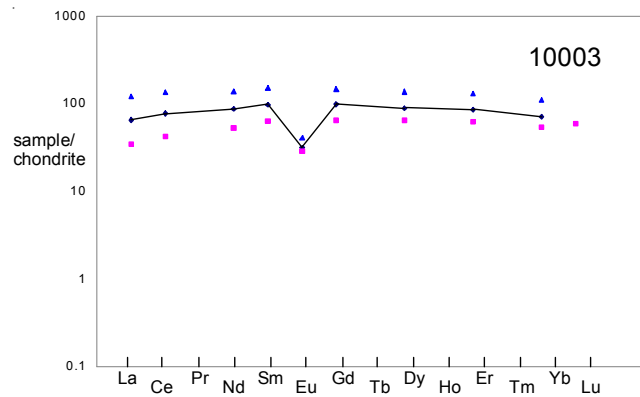

Figure 5: Normalized rare-earth-element composition for low-K basalt 10003 (the line) compared with that of low-K basalt 10020 and high-K basalt 10049 (the dots) (data from Wiesmann et al. 1975).

Radiogenic age dating

Eberhardt et al. (1971) determined a K/Ar age. Papanastassiou and Wasserburg (1975b) determined the age of 10003 by Rb/Sr (figure 6) which agreed closely with that of Stettler et al. (1974) and Turner (1970) by the Ar/Ar technique. Perhaps the most reliable age is that obtained by Ar/Ar plateau of the plagioclase 3.91 ± 0.03 b.y. (figure 7).

Cosmogenic isotopes and exposure ages

O'Kelley et al. (1970) determined the cosmic ray induced activity of ^{22}Na (41 dpm/kg), ^{26}Al (74 dpm/kg), ^{46}Sc (13 dpm/kg), ^{54}Mn (35 dpm/kg) and ^{56}Co (43 dpm/kg). Perkins et al. (1970) determined ^{22}Na (49 dpm/kg), ^{26}Al (75 dpm/kg), ^{46}Sc (8 dpm/kg) and ^{54}Mn (60 dpm/kg). Wrigley and Quaide (1970) determined ^{22}Na (56 dpm/kg) and ^{26}Al (74 dpm/kg).

Turner et al. (1970) and Hintenberger et al. (1971) reported ^{38}Ar exposure ages of 150 m.y and 140 m.y. (respectively). Arvidson et al. (1975) reported a ^{81}Kr exposure age of 140 m.y. (determined by Schwaller 1971). Eugster et al. (1984) reported ^{81}Kr exposure age of 137 m.y.

Other Studies

Oxygen isotopes were reported for mineral separates of 10003 by Onuma et al. (1970) and Taylor and Epstein (1970).

The concentrations of Sm, Nd, Lu and Hf and the isotopic ratios of $^{143}\text{Nd}/^{144}\text{Nd}$ and $^{176}\text{Hf}/^{177}\text{Hf}$ were determined by Unruh et al. (1984).

The abundance and isotopic composition of rare gases in 10003 were determined by Hintenberger et al. (1970) and Eugster et al. (1984).

Price and O'Sullivan (1970) studied the gradient of cosmic ray tracks and obtained the erosion rate by micrometeorite bombardment.

Processing

Apollo 11 samples were originally described and cataloged in 1969 and "recataloged" by Kramer et al. (1977). 10003 was sawn with a circular saw (figure 9 shows the pieces).

List of Photo #s for 10003

- S69-45005 – 006 B&W PET
- S69-45009
- S69-45016
- S69-45019
- S69-45021
- S69-45192 – 193
- S70-49473 – 474
- S70-50549 – 552 color TS
- S75-28696 – 699 ,9 ,12
- S75-20468 – 469 ,38 ,74 ,119
- S76-25538
- S76-25540
- S76-25545
- S76-25547 ,25
- S76-26304 – 305 B&W TS
- S79-27075 – 077 TS color

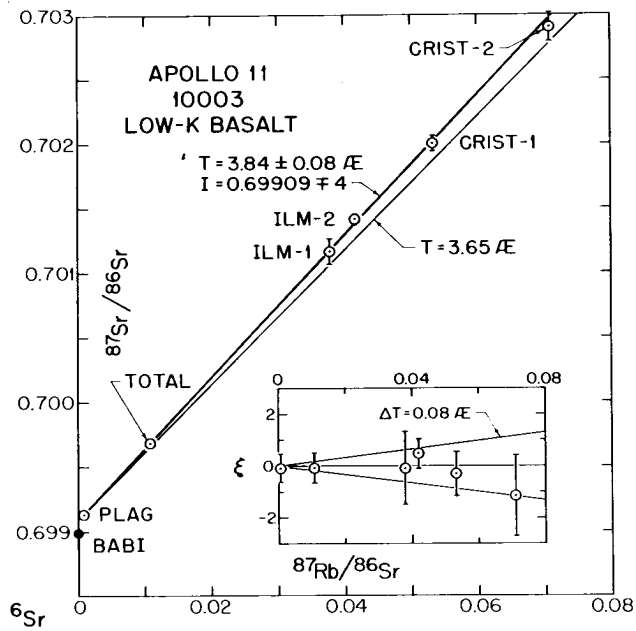

Figure 6: Rb/Sr internal mineral isochron for 10003 (from Papanastassiou and Wasserburg 1975b abs.).

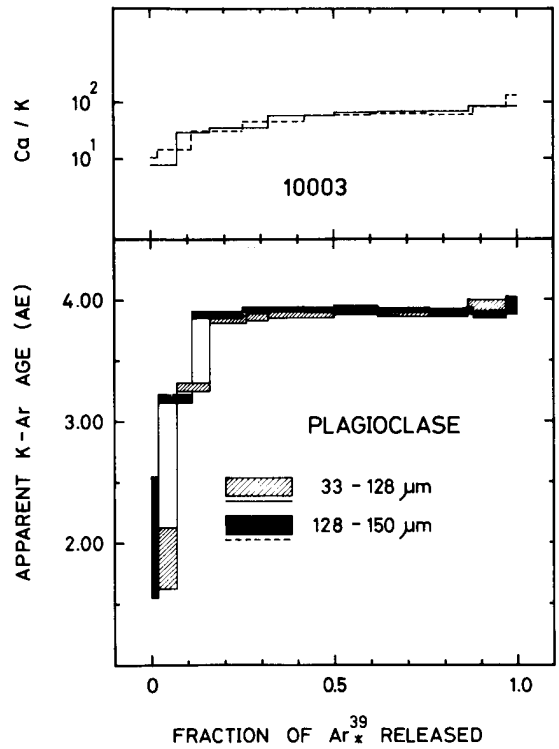

Figure 7: Argon release pattern for plagioclase separated from 10003 (from Stettler et al. 1974).

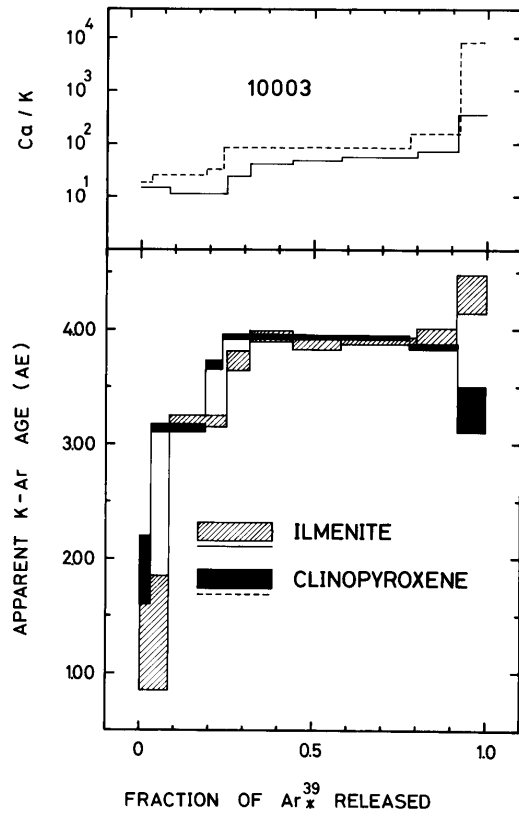

Figure 8: Argon release pattern for low K phases in 10003 (from Stettler et al. 1974).

Summary of Age Data for 10003

	Rb/Sr	Ar/Ar (plag)
Papanastassiou and Wasserburg 1975	3.84 ± 0.08 b.y.	
Stettler et al. 1974		3.91 ± 0.03
Turner 1970		3.92 ± 0.07
Eberhardt et al. 1971		K-Ar

Disclaimer: Uncorrected for new decay constants.

Table 1a. Chemical composition of 10003.

reference weight	Gast70		Wiesmann75 303 mg 198 mg		Compston70	Rose70	Goles70	Rhodes80 1.03 g	O'Kelley70	Perkins70	Wrigley70
SiO ₂ %					39.76	(c) 37.8	(d) 38.3	(e) 39.53	(c)		
TiO ₂					10.5	(c) 12	(d) 11.8	(e) 10.67	(c)		
Al ₂ O ₃					10.43	(c) 11	(d) 10.2	(e) 10.44	(c)		
FeO					19.8	(c) 19.8	(d) 19.7	(e) 20.51	(c)		
MnO					0.3	(c) 0.29	(d) 0.22	(e) 0.29	(c)		
MgO					6.69	(c) 7.2	(d) 8.1	(e) 7.1	(c)		
CaO					11.13	(c) 11	(d) 11.6	(e) 10.8	(c)		
Na ₂ O	0.39		(a) 0.39		(a) 0.4	0.85	(d) 0.36	(e) 0.39	(c)		
K ₂ O	0.057	0.053	(b) 0.057	0.053	(b) 0.06	(c) 0.05	(d)	0.06	(c)	0.058	(f) 0.046 (f)
P ₂ O ₅					0.12	(c)		0.14	(c)		
S %					0.18	(c)					
sum											
Sc ppm							74	(e) 78	(e)		
V							63	(e)			
Cr						1779	(d) 1390	(e) 1620	(e)		
Co							14.1	(e) 14	(e)		
Ni											
Cu											
Zn											
Ga											
Ge ppb											
As											
Se											
Rb	0.49	0.5	(b) 0.49	0.5	(b) 0.62	(c)					
Sr	159	153	(b) 159	153	(b) 161	(c)					
Y					112	(c)					
Zr					309	(c)	560	(e)			
Nb											
Mo											
Ru											
Rh											
Pd ppb											
Ag ppb											
Cd ppb											
In ppb											
Sn ppb											
Sb ppb											
Te ppb											
Cs ppm	0.022		(b) 0.022		(b)						
Ba	108	106	(b) 108	106	(b)		220	(e)			
La	15.5	14.7	(b) 15.5	14.7	(b)		13.5	(e) 15.2	(e)		
Ce	47.2	45.5	(b) 47.2	45.5	(b)		37	(e) 53	(e)		
Pr											
Nd	40	38.3	(b) 40	38.3	(b)						
Sm	14.4	14	(b) 14.4	14	(b)		13	(e) 14.8	(e)		
Eu	1.81	1.76	(b) 1.81	1.76	(b)		1.84	(e) 1.85	(e)		
Gd	19.5	19	(b) 19.5	19	(b)						
Tb							3.5	(e) 3.3	(e)		
Dy	21.9	21.6	(b) 21.9	21.6	(b)						
Ho							4	(e)			
Er	13.6	13.4	(b) 13.6	13.4	(b)						
Tm											
Yb	13.2	13	(b) 11.7	11.6	(b)		15.3	(e) 12	(e)		
Lu	1		(b) 1		(b)		2.62	(e) 1.76	(e)		
Hf							11.6	(e) 11.4	(e)		
Ta								2	(e)		
W ppb											
Re ppb											
Os ppb											
Ir ppb											
Pt ppb											
Au ppb											
Th ppm					1.1	(c)		1.8	(e)	1.01	(f) 1.08 (f) 0.9 (f)
U ppm							0.31	(e)	0.26	(f) 0.29	(f) 0.25 (f)

technique: (a) AA, (b) IDMS, (c) XRF, (d) semi micro XRF, (e) INAA, (f) radiation counting

Table 1b. Chemical composition of 10003.

reference	Haskin70	Annell70	Neal2001
<i>weight</i>			
SiO ₂ %			
TiO ₂			
Al ₂ O ₃			
FeO			
MnO		0.33	(b)
MgO			
CaO			
Na ₂ O			
K ₂ O			
P ₂ O ₅			
S %			
<i>sum</i>			
Sc ppm		94	(b) 75.5 (c)
V		82	(b) 48.9 (c)
Cr		1860	(b) 1268 (c)
Co		15	(b) 15.7 (c)
Ni		2.7	(b) 8.32 (c)
Cu		6.7	(b) 37.6 (c)
Zn			58.4 (c)
Ga		4.7	(b) 4.02 (c)
Ge ppb			
As			
Se			
Rb		1	(b) 0.79 (c)
Sr		150	(b) 148.8 (c)
Y		113	(b) 117 (c)
Zr		380	(b) 338.8 (c)
Nb		21	(b) 20.3 (c)
Mo			0.18 (c)
Ru			
Rh			
Pd ppb			
Ag ppb			
Cd ppb			
In ppb			
Sn ppb			
Sb ppb			40 (c)
Te ppb			
Cs ppm			0.05 (c)
Ba		160	(b) 103.1 (c)
La	14.1	(a) 15	(b) 17.5 (c)
Ce	41.3	(a)	55.6 (c)
Pr			7.96 (c)
Nd	42.5	(a)	44.4 (c)
Sm	13.1	(a)	15.6 (c)
Eu	1.8	(a)	1.87 (c)
Gd	17	(a)	20.5 (c)
Tb	3.26	(a)	3.6 (c)
Dy	22.4	(a)	22.8 (c)
Ho			4.79 (c)
Er	12	(a)	14 (c)
Tm			1.85 (c)
Yb	11.9	(e)	13.2 (c)
Lu	1.69	(a)	1.84 (c)
Hf			10.2 (c)
Ta			1.32 (c)
W ppb			0.22 (c)
Re ppb			
Os ppb			
Ir ppb			
Pt ppb			
Au ppb			
Th ppm			0.94 (c)
U ppm			0.28 (c)

technique: (a) INAA, (b) emission spec., (c) ICP-MS

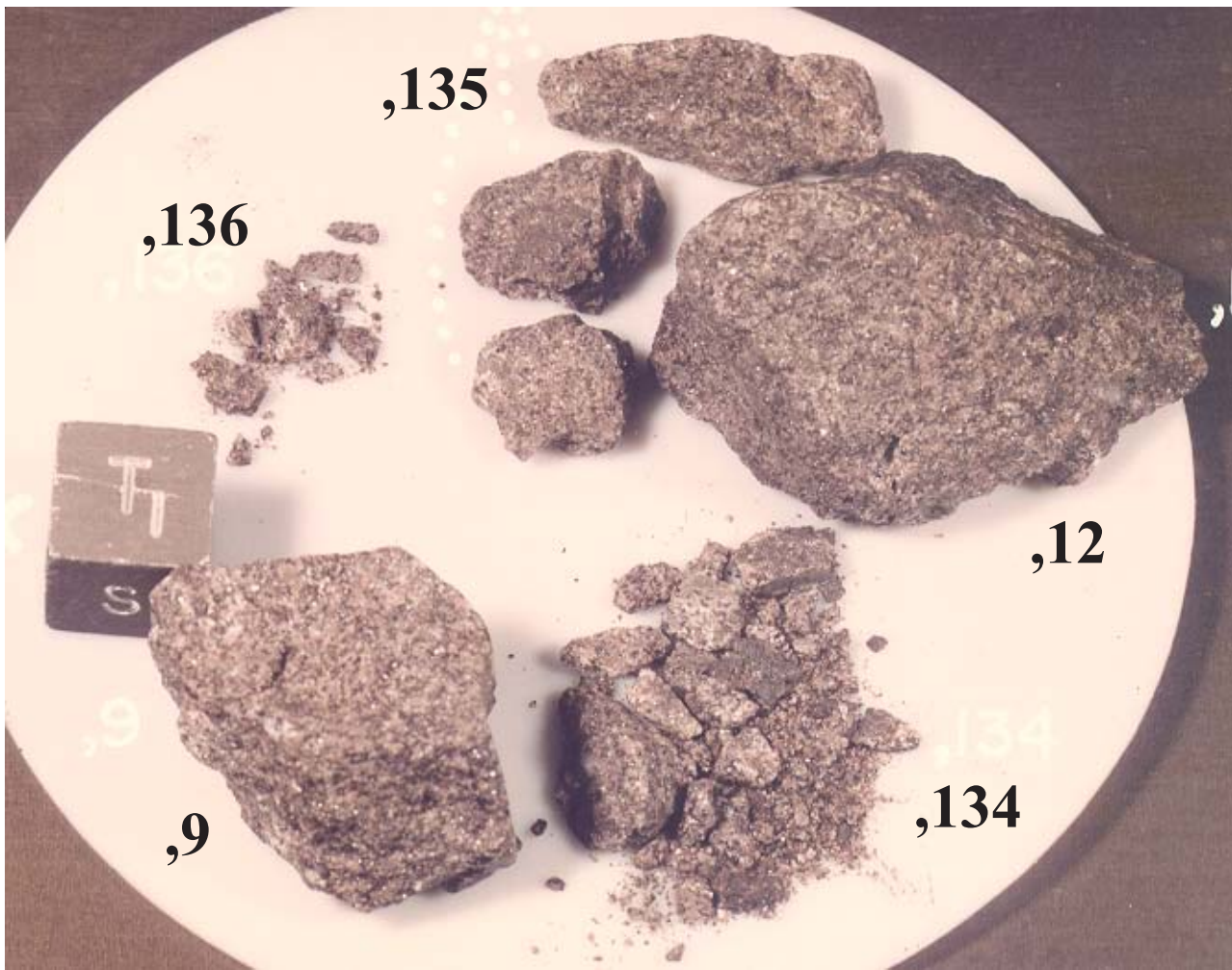

Figure 9: Group photo of 10003,12 and ,9. Cube is 1 cm. NASA S75-28698

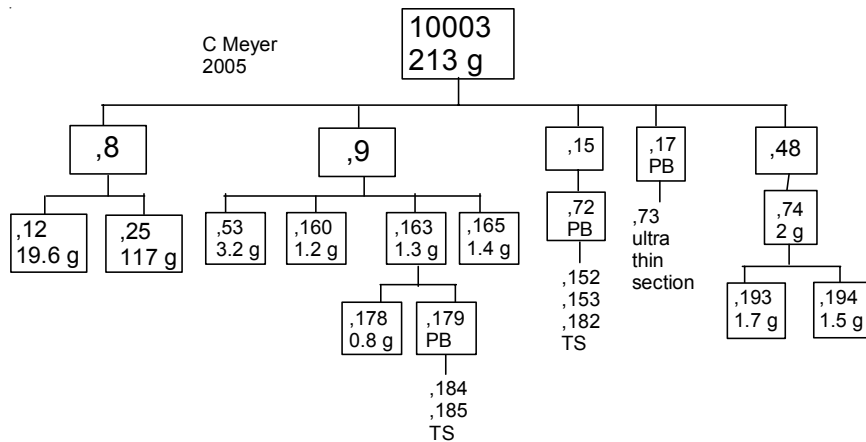

Table 2

	U ppm	Th ppm	K ppm	Rb ppm	Sr ppm	Nd ppm	Sm ppm	technique
Papanastassiou 1975b			433	?				idms
Perkins et al. 1970	0.29	1.08	460					rad. Count.
O'Kelley et al. 1970	0.26	1.01	480					rad. Count.
Gast and Hubbard 1970			470	0.49	158.6	40	14.5	idms
Tatsumoto et al. 1970	0.268	1.029						idms
Compston et al. 1970		1.1		0.62	160.9			idms

References for A11

- Arvidson R., Crozaz G., Drozd R.J., Hohenberg C.M. and Morgan C.J. (1975) Cosmic ray exposure ages of features and events at the Apollo landing sites. *The Moon* **13**, 259-276.
- Annell C.S. and Helz A.W. (1970) Emission spectrographic determination of trace elements in lunar samples from Apollo 11. *Proc. Apollo 11 Lunar Sci. Conf.* 991-994.
- Bailey J.C., Champness P.E., Dunham A.C., Esson J., Fyfe W.S., MacKenzie W.S., Stumpfl E.F. and Zussman J. (1970) Mineralogy and petrology of Apollo 11 lunar samples. *Proc. Apollo 11 Lunar Sci. Conf.* 169-194.
- Beatty D.W. and Albee A.L. (1978) Comparative petrology and possible genetic relations among the Apollo 11 basalts. *Proc. 9th Lunar Planet. Sci. Conf.* 359-463.
- Compston W., Arriens P.A., Vernon M.J. and Chappell B.W. (1970a) Rubidium-strontium chronology and chemistry of lunar material. *Science* **167**, 474-476.
- Compston W., Chappell B.W., Arriens P.A. and Vernon M.J. (1970b) The chemistry and age of Apollo 11 lunar material. *Proc. Apollo 11 Lunar Sci. Conf.* 1007-1027.
- Eberhardt P., Geiss J., Grogler N., Krahenbuhl U., Morgeli M. and Stettler A. (1971a) Potassium-Argon age of Apollo 11 rock 10003. *Earth Planet. Sci. Lett.* **11**, 245-246.
- Eugster O., Eberhardt P., Geiss J., Grögler N. and Schwaller H. (1984b) Cosmic ray exposure histories and ²³⁵U-¹³⁶Xe dating of Apollo 11, Apollo 12, and Apollo 17 mare basalts. *Proc. 15th Lunar Planet. Sci. Conf.* in *J. Geophys. Res.* **89**, C171-C181.
- Gamble R.P., Coish R.A. and Taylor L.A. (1978) The consanguinity of the oldest Apollo 11 mare basalts. *Proc. 9th Lunar Planet. Sci. Conf.* 495-507.
- Gast P.W., Hubbard N.J. and Wiesmann H. (1970b) Chemical composition and petrogenesis of basalts from Tranquillity Base. *Proc. Apollo 11 Lunar Sci. Conf.* 1143-1163.
- Goles G.G., Randle K., Osawa M., Lindstrom D.J., Jerome D.Y., Steinborn T.L., Beyer R.L., Martin M.R. and McKay S.M. (1970) Interpretations and speculations on elemental abundances in lunar samples. *Proc. Apollo 11 Lunar Sci. Conf.* 1177-1194.
- Guggisberg S., Eberhardt P., Geiss J., Grogler N., Stettler A., Brown G.M. and Peckett A. (1979) Classification of the Apollo-11 basalts according to Ar³⁹-Ar⁴⁰ ages and petrological properties. *Proc. 10th Lunar Planet. Sci. Conf.* 1-39.
- Hafner S.S. and Virgo D. (1970) Temperature-dependent cation distributions in lunar and terrestrial pyroxenes. *Proc. Apollo 11 Lunar Sci. Conf.* 2183-2198.
- Haggerty S.E., Boyd F.R., Bell P.M., Finger L.W. and Bryan W.B. (1970) Opaque minerals and olivine in lavas and breccias from Mare Tranquillitatis. *Proc. Apollo 11 Lunar Sci. Conf.* 513-538.
- Haskin L.A., Allen R.O., Helmke P.A., Paster T.P., Anderson M.R., Korotev R.L. and Zweifel K.A. (1970) Rare earths and other trace elements in Apollo 11 lunar samples. *Proc. Apollo 11 Lunar Sci. Conf.* 1213-1231.
- Hintenberger H., Weber H.W. and Takaoka N. (1971) Concentrations and isotopic abundances of the rare gases in lunar matter. *Proc. 2nd Lunar Sci. Conf.* 1607-1625.
- James O.B. and Jackson E.D. (1970) Petrology of the Apollo 11 ilmenite basalts. *J. Geophys. Res.* **75**, 5793-5824.
- Kramer F.E., Twedell D.B. and Walton W.J.A. (1977) **Apollo 11 Lunar Sample Information Catalogue** (revised). Curator's Office, JSC 12522
- LSPET (1969) Preliminary examination of lunar samples from Apollo 11. *Science* **165**, 1211-1227.
- McGee P.E., Warner J.L. and Simonds C.H. (1977) Introduction to the Apollo Collections. Part I: Lunar Igneous Rocks. Curators Office, JSC.
- Neal C.R. (2001) Interior of the moon: The presence of garnet in the primitive deep lunar mantle. *J. Geophys. Res.* **106**, 27865-27885.
- O'Kelley G.D., Eldridge J.S., Schonfeld E. and Bell P.R. (1970) Primordial radionuclide abundances, solar proton and cosmic ray effects and ages of Apollo 11 lunar samples

- by non-destructive gamma-ray spectrometry. *Proc. Apollo 11 Lunar Sci. Conf.* 1407-1424.
- Onuma N., Clayton R.N. and Mayeda T. (1970) Apollo 11 rocks: Oxygen isotope fractionation between minerals and an estimate of the temperature of formation. *Proc. Apollo 11 Lunar Sci. Conf.* 1429-1434.
- O'Hara M.J., Biggar G.M., Hill P.G., Jefferies B. and Humphries D.J. (1974) Plagioclase saturation in lunar high-Titanium basalt. *Earth Planet. Sci. Lett.* **21**, 253-268.
- Papanastassiou D.A., Wasserburg G.J. and Burnett D.S. (1970a) Rb-Sr ages of lunar rocks from the Sea of Tranquillity. *Earth Planet. Sci. Lett.* **8**, 1
- Papanastassiou D.A. and Wasserburg G.J. (1971a) Lunar chronology and evolution from Rb-Sr studies of Apollo 11 and 12 samples. *Earth Planet. Sci. Lett.* **11**, 37-62.
- Papanastassiou D.A. and Wasserburg G.J. (1975b) A Rb-Sr study of Apollo 17 boulder 3: Dunite clast, microclasts, and matrix (abs). *Lunar Sci.* **VI**, 631-633. Lunar Planetary Institute, Houston.
- Perkins R.W., Rancitelli L.A., Cooper J.A., Kaye J.H. and Wogman N.A. (1970) Cosmogenic and primordial radionuclide measurements in Apollo 11 lunar samples by nondestructive analysis. *Proc. Apollo 11 Lunar Sci. Conf.* 1455-1469.
- Price P.B. and O'Sullivan D. (1970) Lunar erosion rate and solar flare paleontology. *Proc. Apollo 11 Lunar Sci. Conf.* 2351-2359.
- Rhodes J.M. and Blanchard D.P. (1980) Chemistry of Apollo 11 low-K mare basalts. *Proc. 11th Lunar Planet. Sci. Conf.* 49-66.
- Rose H.J., Cuttitta F., Dwornik E.J., Carron M.K., Christian R.P., Lindsay J.R., Ligon D.T. and Larson R.R. (1970b) Semimicro X-ray fluorescence analysis of lunar samples. *Proc. Apollo 11 Lunar Sci. Conf.* 1493-1497.
- Ross M., Bence A.E., Dwornik E.J., Clark J.R. and Papike J.J. (1970) Mineralogy of the lunar clinopyroxenes, augite and pigeonite. *Proc. Apollo 11 Lunar Sample Conf.* 839-848.
- Schmitt H.H., Lofgren G., Swann G.A. and Simmons G. (1970) The Apollo 11 samples: Introduction. *Proc. Apollo 11 Lunar Science Conf.* 1-54.
- Stettler A., Eberhardt P., Geiss J., Grogler N. and Maurer P. (1974) On the duration of the lava flow activity in Mare Tranquillitatis. *Proc. 5th Lunar Sci. Conf.* 1865-1888.
- Stewart D.B., Appleman D.E., Huebner J.S. and Clark J.R. (1970) Crystallography of some lunar plagioclase. *Science* **167**, 634-635.
- Tatsumoto M. (1970) Age of the Moon: An isotopic study of U-Th-Pb systematics of Apollo 11 lunar samples - II. *Proc. Apollo 11 Lunar Sci. Conf.* 1595-1612.
- Taylor H.P. and Epstein S. (1970a) O18/O16 ratios of Apollo 11 lunar rocks and minerals. *Proc. Apollo 11 Lunar Sci. Conf.* 1613-1626.
- Turner G. (1970a) Argon-40/argon-39 dating of lunar rock samples. *Proc. Apollo 11 Lunar Sci. Conf.* 1665-1684.
- Wiesmann H. and Hubbard N.J. (1975) A compilation of the Lunar Sample Data Generated by the Gast, Nyquist and Hubbard Lunar Sample PI-Ships. Unpublished. JSC
- Unruh D.M., Stille P., Patchett P.J. and Tatsumoto M. (1984) Lu-Hf and Sm-Nd evolution in lunar mare basalts. *Proc. 14th Lunar Planet. Sci. Conf.* in *J. Geophys. Res.* **88**, B459-B477.
- Wrigley R.C. and Quaide W.L. (1970) Al26 and Na22 in lunar surface materials: Implications for depth distribution studies. *Proc. Apollo 11 Lunar Sci. Conf.* 1751-1755.