

10044
Ilmenite Basalt (low K)
247.5 grams



Figure 1: Photo of 10044,54. Cube is 1 cm. NASA S75-31692.

Introduction

Lunar sample 10044 was collected in the area between the LM and the double elongate crater to the southwest of the LM and was returned in ALSRC #1003. It is a low-K variety of ilmenite basalt typical of Apollo 11, although analyses show it has lower Ti than the others. Figure 1 is an enlargement showing the igneous texture of a piece of 10044.

The crystallization age of 10044 has been determined as 3.7 b.y. and the cosmic ray exposure age is ~80 m.y. (age of West Crater?).

Petrography

Schmitt et al. (1970) termed 10044 as a “coarse-grained, vuggy, ophitic, cristobalite basalt” and James

and Jackson (1970) termed it a “medium grained ophitic basalt” (figure 2). Bailey et al. (1970) reported that the pyroxene was equant and up to 2 mm, and plagioclase was 1.5 mm in size. Smith et al. (1970) and others have termed 10044 a “microgabbro”. Albee and Chodos (1970) and Agrell et al. (1970) also reported petrographic details.

McGee et al. (1977) describe 10044 as “a coarse-grained porphyritic basalt which consists of subhedral to anhedral phenocrysts of pyroxene (1.0 -2.0 mm) set in a subophitic matrix of plagioclase tablets (0.2 x1.0 to 0.4x2.0 mm), anhedral pyroxene grains (0.6-0.8 mm), and ilmenite.” Pyroxene is chemically zoned to Fe-rich pyroxferroite at the rims. Ilmenite is present

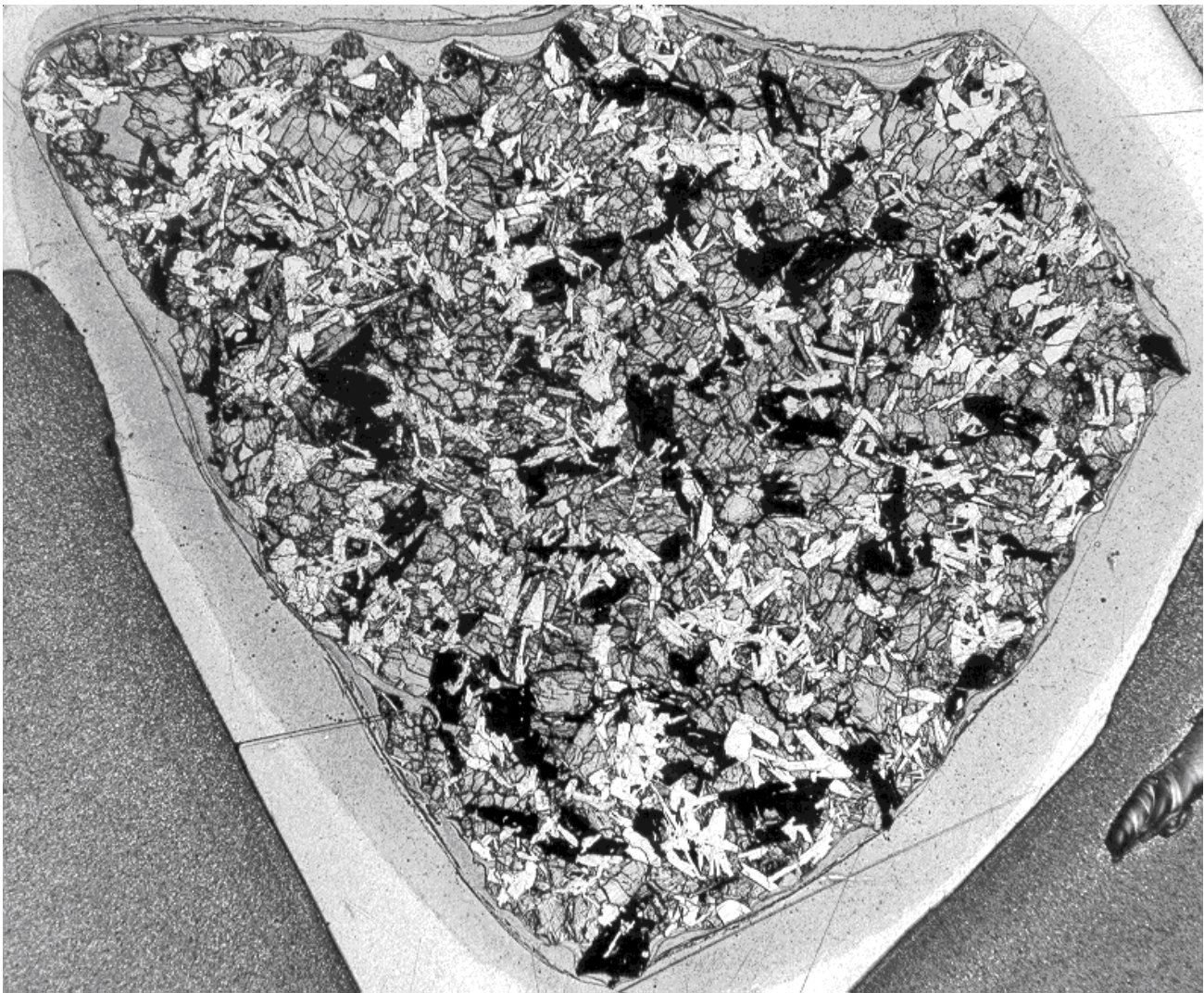

Figure 2: Thin section of 10044 showing coarse basaltic texture. Field of view about 1 cm. NASA S69-59344.

as laths (0.3-0.8 mm) and as irregular-shaped bodies. Interstitial areas are filled with anhedral cristobalite, troilite with metallic iron “blebs”, K-rich glass and irregular-shaped vugs up to 0.3 mm (figure 3).

Beaty and Albee (1978) note that 10044, 10047 and 10058 “are so similar to one another that it seems quite likely that these rocks are fragments of a larger block.”

Dymek et al. (1975) also noted the remarkable similarity of 10044 to 75055.

Mineralogy

Olivine: There is essentially no olivine in 10044, but Fuchs (1970) reported a thin grain of fayalite between ilmenite and pyroxferroite.

Mineralogical Mode for 10044

| | Beaty and Albee 1978 | Bailey et al. 1970 | | McGee et al. 1977 |
|-------------|----------------------|--------------------|------|-------------------|
| Olivine | 0.1 | | | |
| Pyroxene | 44.8 | 46.4 | 47.3 | 45 - 59 |
| Plagioclase | 35 | 34.1 | 33.1 | 33 - 37 |
| Ilmenite | 12.6 | 12.3 | 14.4 | 6 - 12 |
| mesostasis | | | | |
| silica | 6.7 | 6.3 | 5.2 | 4 - 6 |
| troilite | 0.4 | | | tr. |
| phosphate | 0.1 | | | tr. |



Figure 3: Photomicrographs of thin section of 10044 (top is plane polarized light, bottom is with crossed-polarizers). Field of view is 2.5 mm. NASA S70-49983 and 49984.

Pyroxene: Albee and Chodos (1970), Hafner and Virgo (1970) and Beatty and Albee (1978) reported the composition of pyroxene (figure 4). Albee and Chodos (1970) discovered that the pyroxene in 10044 was chemically zoned in sectors (figure 5). They found that the (010) sector contains about twice as much Ti, Al and Cr as the adjacent (001) sector; the substitution of ^{4+}Ti for divalent 6-fold coordinated cations is balanced by twice as much ^{3+}Al replacing 4-fold coordinated ^{4+}Si . Bailey et al. (1970) reported the cell dimensions for exsolved pyroxene. The exsolution of pyroxene in 10044 was studied by Fernandez-Moran et al. (1970). Hafner and Virgo (1970) and Gay et al. (1970) determined the Mossbauer spectra (figure 6) and determined the site distribution of cations in pyroxene.

Pyroxferroite: Chao et al. (1970) give the optical, chemical and crystallographic data for pyroxferroite.

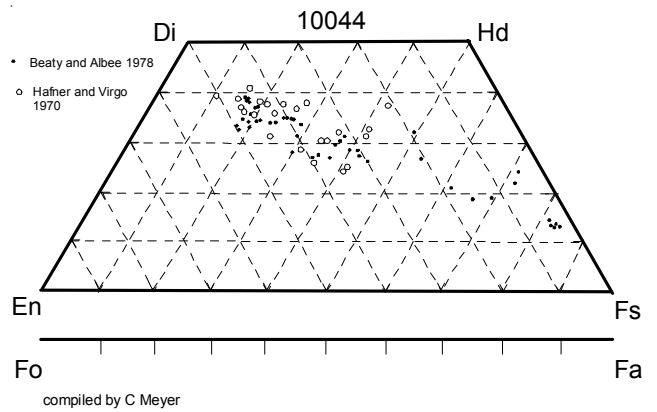

Figure 4: Pyroxene composition of 10044 (replotted from Beatty and Albee 1978).

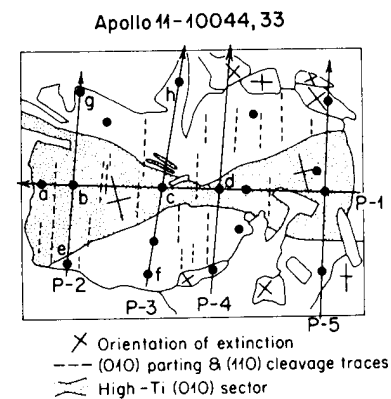

Figure 5: Sketch map of sector-zoned pyroxene in 10044 (from Albee and Chodos 1970).

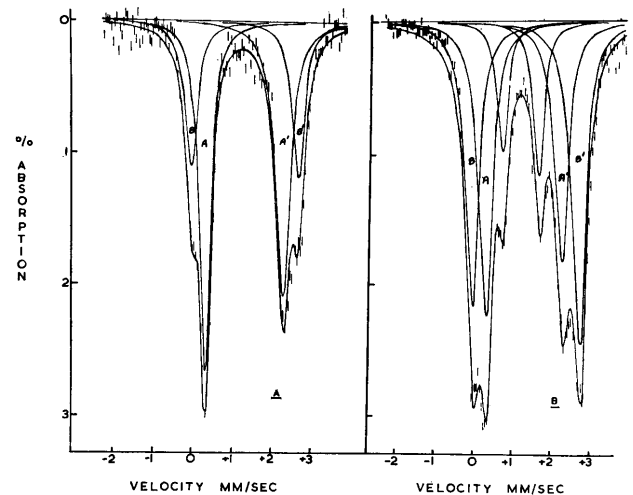

Figure 6: Mossbauer spectra at 80 deg K for pyroxene fractions of 10044 (from Gay et al. 1970).

Plagioclase: Goles et al. (1970) and Philpotts and Schntzler (1970) determined the trace element content of plagioclase separates for 10044 (however, see note about sample mix-up).

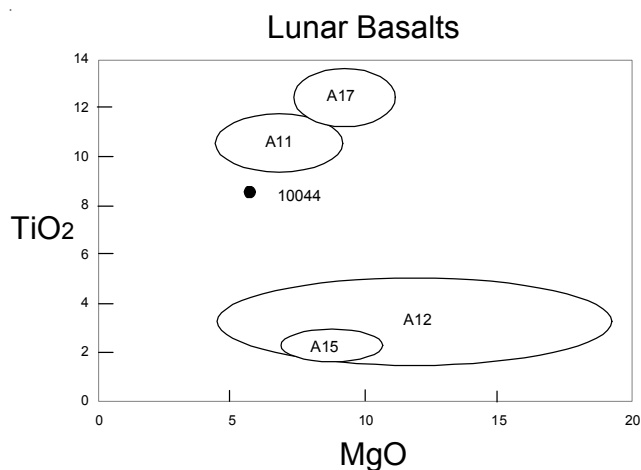

Figure 7: Composition of 10044 compared with that of other Apollo lunar samples.

Ilmenite: Cameron (1970) and Smith et al. (1970) found ilmenite was uniform in composition. Philpotts and Schnetzler (1970) determined the trace element content of ilmenite separate (figure 9), but clearly the ilmenite separate was contaminated by attached mesostasis with high trace element content.

Ulvospinel: Cameron (1970) reported ulvospinel with associated ilmenite and native iron.

Silica: This rock has abundant cristobalite (Beaty and Albee 1978) as well as tridymite (Smith et al. 1970).

Apatite: Albee and Chodos (1970) reported an analysis apatite in 10044. Fuchs (1970) gives analyses with 3.3 wt. % fluorine included.

Y-Zr silicate: Cameron (1970) reported a new mineral with abundant yttrium and zirconium in 10044.

Chemistry

Engel and Engel (1970) and others reported the chemical composition (table 1). Rhodes and Blanchard (1980) and Neal (2001) reanalyzed the sample. Sample 10044 may have lower Ti than the other Apollo 11 basalts (figure 7), but it has similar REE (figure 8). Reed and Jovanovic (1970) determined F, Cl, Br, I, Li and Hg in 10044. Moore et al. (1970) reported 102 ppm C and 98 ppm N (and termed it breccia).

Both Goles et al. (1970) and Philpotts and Schnetzler (1970) analyzed carefully prepared mineral separates (figure 9).

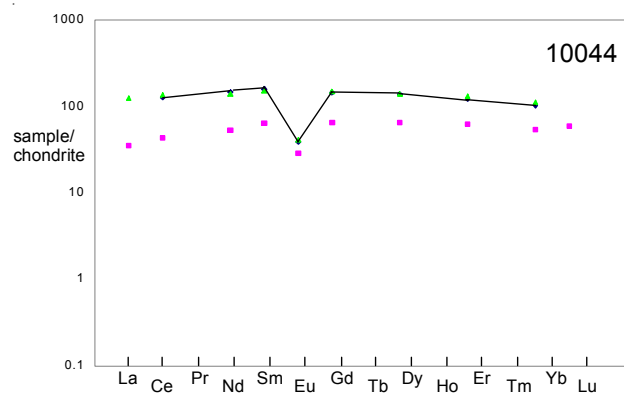

Figure 8: Normalized rare-earth-element composition for high-K basalt 10044 (the line) compared with that of low-K basalt 10020 and high-K basalt 10049 (the dots) (data from Wiesmann et al. 1975).

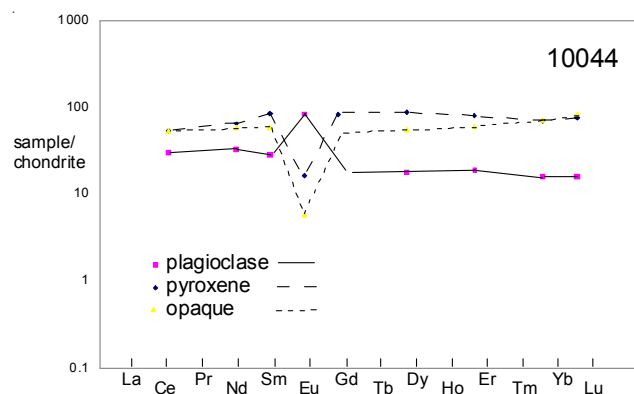

Figure 9: Normalized rare-earth-element diagram for mineral separates of 10044 (data from Philpotts and Schnetzler 1970).

Note: the analysis of 10044 by Philpotts and Schnetzler (1970) may be that of 10024 instead – see page 1473.

Radiogenic age dating

Albee et al. (1970) and Papanastassiou et al. (1970) determined the Rb/Sr isochron age as ~ 3.7 b.y. for 10044 (figure 10). Davis et al. (1971) determined 4.00 ± 0.07 b.y. Turner (1970) and Guggisberg et al. (1979) determined the precise ages as 3.73 ± 0.05 b.y. and 3.71 ± 0.04 b.y. (figure 11) by the Ar/Ar plateau technique. Murthy et al. (1970) determined the Sr isotopes.

Cosmogenic isotopes and exposure ages

Hohenberg et al. (1970) determined a ^{81}Kr exposure age of 70 ± 17 m.y. and 72 m.y. by ^{126}Xe (as calculated by Srinivasan 1974). Hintenberger et al. (1971) determined an ^{38}Ar exposure age of 93 m.y. Turner et

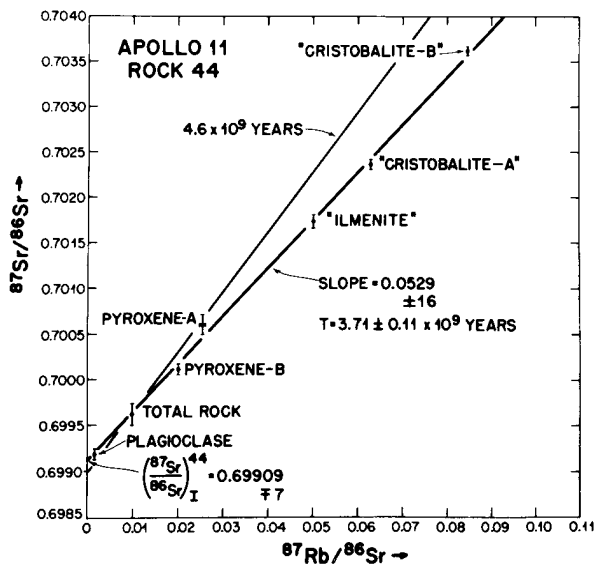

Figure 10: Rb/Sr crystallization age of 10044 (from Papanastassiou and Wasserburg 1970).

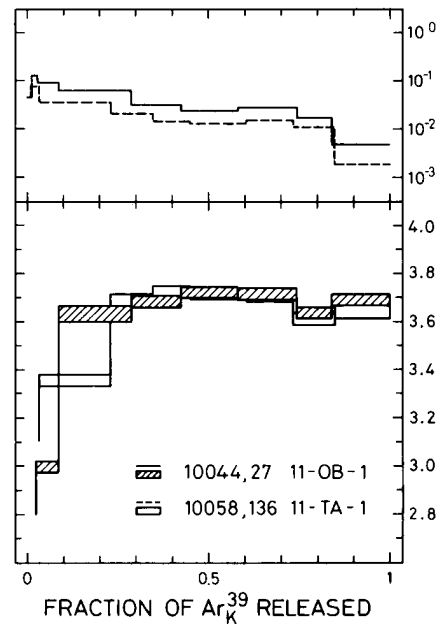

Figure 11: Ar/Ar plateau age of high K and low K Apollo 11 basalts (from Guggisberg et al. 1979).

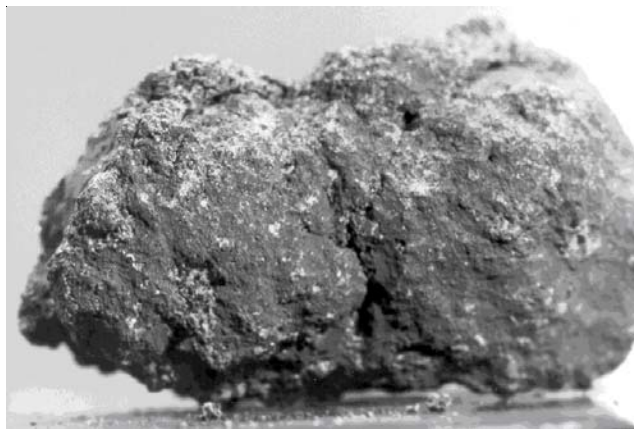

Figure 12: Front and back photos of 10044 from PET. NASA S69-45540 and 541.

al. (1970) and Guggisberg et al. (1979) determined ^{38}Ar exposure ages of 70 m.y. and 82 m.y. respectively.

Other Studies

Oxygen isotopes were reported for mineral separates of 10044 by Onuma et al. (1970) and Taylor and Epstein (1970) (figure 13).

Summary of Age Data for 10044

| | Rb/Sr | Ar/Ar plateau |
|----------------------------|----------------------|-----------------|
| Albee et al. 1970 | 3.70 ± 0.07 b.y. | |
| Papanastassiou et al. 1970 | 3.71 ± 0.11 | |
| Turner 1970 | | 3.73 ± 0.05 |
| Hintenberger et al. 1970 | | 3.9 whole rock |
| Davis et al. 1971 | | 4.00 ± 0.07 |
| Guggisberg et al. 1979 | | 3.71 ± 0.04 |

Disclaimer: Ages not corrected for new decay constants.

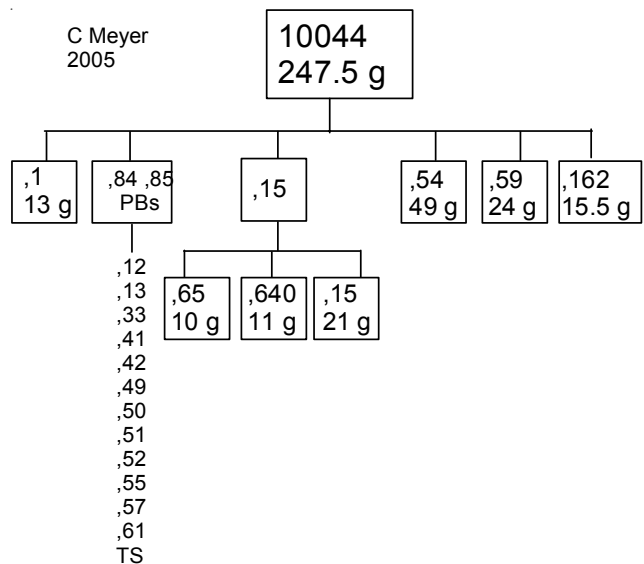

Table 1a. Chemical composition of 10044.

| reference weight | Engel70 | Tera70 | Wanke70 | Philpotts69 Philpotts70 286 mg 10024 ????? | Rhodes80 1.33 g | Wakita70 849 mg 1.027 g | Kharkar71 Turekian 70 | Murthy 70 |
|------------------|-----------|-----------|----------|--|--------------------|-------------------------------|--------------------------|-----------|
| SiO2 % | 42.01 (a) | | 43 | | 42.89 (d) | 52 41.5 (c) | | |
| TiO2 | 8.81 (a) | | 10.5 | | 8.47 (d) | 9.84 9.5 (c) | 8.5 (c) | |
| Al2O3 | 11.67 (a) | | 11.9 | | 10.49 (d) | 8.7 11.3 (c) | | |
| FeO | 17.98 (a) | | 17.1 | | 18.46 (d) | 20.4 18.5 (c) | 17.5 (c) | |
| MnO | 0.24 (a) | | 0.26 | | 0.28 (d) | 0.3 0.26 (c) | 0.25 (c) | |
| MgO | 6.25 (a) | | 6.47 | | 5.98 (d) | 6.8 5.8 (c) | | |
| CaO | 12.18 (a) | 11.7 (b) | 7.13 | | 12.4 (d) | 11.7 12.5 (c) | 12.7 (c) | |
| Na2O | 0.48 (a) | 0.45 | 0.48 | | 0.38 (d) | 0.37 0.5 (c) | 0.49 (c) | |
| K2O | 0.11 (a) | 0.094 (b) | 0.1 | 0.29 (b) | 0.11 (d) | 0.11 0.13 (c) | | 0.1 (b) |
| P2O5 | 0.08 (a) | | | | 0.12 (d) | | | |
| S % sum | | | | | | | | |
| Sc ppm | 100 (a) | | 92 (c) | | 78 (c) | 105 84 (c) | 100 (c) | |
| V | 66 (a) | | | | | 50 27 (c) | | |
| Cr | 1700 (a) | | 1300 (c) | | 1250 (c) | 1570 1190 (c) | 1420 (c) | |
| Co | 12 (a) | | 11 (c) | | 9.5 (c) | 15 16 (c) | 13 (c) | |
| Ni | 7 (a) | | | | | | | |
| Cu | 9 (a) | | 4.2 (c) | | | | | |
| Zn | | | | | | | | |
| Ga | | | 5.1 (c) | | 8.9 (d) | | | |
| Ge ppb | | | | | | | | |
| As | | | | | | | | |
| Se | | | | | | | | |
| Rb | | 0.886 (b) | 5.1 (c) | 5.64 (b) | 1.4 (d) | | | 1.15 (b) |
| Sr | 130 (a) | | | 167 (b) | 230 (d) | | | 224 (b) |
| Y | 180 (a) | | | | 148 (d) | | | |
| Zr | 400 (a) | | | | | 1140 420 (c) | | |
| Nb | | | | | | | | |
| Mo | | | | | | | | |
| Ru | | | | | | | | |
| Rh | | | | | | | | |
| Pd ppb | | | | | | | | |
| Ag ppb | | | | | | | | |
| Cd ppb | | | | | | | | |
| In ppb | | | 3.2 (c) | | | | | |
| Sn ppb | | | | | | | | |
| Sb ppb | | | | | | | | |
| Te ppb | | | | | | | | |
| Cs ppm | | 0.034 (b) | | | | | | |
| Ba | 130 (a) | 95 (b) | 234 (c) | 285 (b) | | 260 230 (c) | | 128 (b) |
| La | | | 12 (c) | | 9.9 (c) | 8.7 10 (c) | 10.5 (c) | |
| Ce | | | 44 (c) | 76.6 (b) | 38 (c) | | 37.6 (c) | |
| Pr | | | | | | | | |
| Nd | | | 50 (c) | 66.1 (b) | | | | |
| Sm | | | 17.9 (c) | 23.4 (b) | 16.3 (c) | 17.7 19.7 (c) | 11.4 (c) | |
| Eu | | | 2.69 (c) | 2.21 (b) | 2.28 (c) | 2 3.4 (c) | 3 (c) | |
| Gd | | | 24 (c) | 28.6 (b) | | | | |
| Tb | | | 4.5 (c) | | 3.4 (c) | | 3.9 (c) | |
| Dy | | | | 33.6 (b) | | | 27.6 (c) | |
| Ho | | | | | | | | |
| Er | | | | 19.3 (b) | | | | |
| Tm | | | | | | | | |
| Yb | | | 15 (c) | 16.6 (b) | 13 (c) | 16 16 (c) | 10.4 (c) | |
| Lu | | | 1.96 (c) | | 1.86 (c) | 2.1 2.2 (c) | 2.11 (c) | |
| Hf | | | 12 (c) | | 11.6 (c) | 15 18 (c) | 14 (c) | |
| Ta | | | 2 (c) | | 2.5 (c) | | 1.5 (c) | |
| W ppb | | | 240 (c) | | | | | |
| Re ppb | | | | | | | | |
| Os ppb | | | | | | | | |
| Ir ppb | | | | | | | | |
| Pt ppb | | | | | | | | |
| Au ppb | | | 1.9 (c) | | | | | |
| Th ppm | | | 0.98 (c) | | 0.8 (c) | 0.6 1.4 (c) | | |
| U ppm | | | 0.28 (c) | | | | | |

technique: (a) wet and mixed, (b) IDMS, (c) INAA & RNAA (d) XRF

Table 1b. Chemical composition of 10044.

| reference weight | Agrell70 | Bailey70 | Brown70 | Dymek75 | Beaty78 | Neal2001 |
|--------------------------------|----------|----------|----------|---------|---------|--------------|
| SiO ₂ % | 42.46 | (a) | | 41.61 | 42.21 | (e) |
| TiO ₂ | 9.18 | (a) | | 10.05 | 10.25 | (e) |
| Al ₂ O ₃ | 10.21 | (a) | | 11.1 | 10.35 | (e) |
| FeO | 17.6 | (a) | | 17.73 | 17.88 | (e) |
| MnO | 0.28 | (a) | | 0.27 | 0.27 | (e) |
| MgO | 5.96 | (a) | | 5.58 | 5.95 | (e) |
| CaO | 12.25 | (a) | | 12.33 | 12.08 | (e) |
| Na ₂ O | 0.48 | (a) | | 0.51 | 0.5 | (e) |
| K ₂ O | 0.11 | (a) | | 0.16 | 0.03 | (e) |
| P ₂ O ₅ | 0.04 | (a) | | 0.07 | 0.04 | (e) |
| S % | 0.18 | (a) | | 0.06 | 0.22 | (e) |
| sum | | | | | | |
| Sc ppm | | | | | | 90.9 (f) |
| V | | | | | | 45.2 (f) |
| Cr | 1430 | (a) | 1180 (d) | 1570 | 1630 | (e) 1168 (f) |
| Co | | | | | | 14.3 (f) |
| Ni | | | 4 (d) | | | 1.46 (f) |
| Cu | | | 4 (d) | | | 37.6 (f) |
| Zn | | | 3 (d) | | | 64.1 (f) |
| Ga | | | | | | 4.97 (f) |
| Ge ppb | | | | | | |
| As | | | | | | |
| Se | | | | | | |
| Rb | | | 1 (d) | | | 1.22 (f) |
| Sr | | 250 (d) | 206 (d) | | | 215 (f) |
| Y | | 215 (d) | 147 (d) | | | 159 (f) |
| Zr | | 465 (d) | 366 (d) | | | 334 (f) |
| Nb | | 41 (d) | 21 (d) | | | 28.4 (f) |
| Mo | | | | | | 0.12 (f) |
| Ru | | | | | | |
| Rh | | | | | | |
| Pd ppb | | | | | | |
| Ag ppb | | | | | | |
| Cd ppb | | | | | | |
| In ppb | | | | | | |
| Sn ppb | | | | | | |
| Sb ppb | | | | | | 30 (f) |
| Te ppb | | | | | | |
| Cs ppm | | | | | | 0.02 (f) |
| Ba | | | 82 (d) | | | 118 (f) |
| La | | | | | | 11.7 (f) |
| Ce | | | | | | 42.1 (f) |
| Pr | | | | | | 7.75 (f) |
| Nd | | | | | | 43.1 (f) |
| Sm | | | | | | 17.1 (f) |
| Eu | | | | | | 2.76 (f) |
| Gd | | | | | | 24.6 (f) |
| Tb | | | | | | 4.23 (f) |
| Dy | | | | | | 27.7 (f) |
| Ho | | | | | | 5.64 (f) |
| Er | | | | | | 16 (f) |
| Tm | | | | | | 2.2 (f) |
| Yb | | | | | | 14.4 (f) |
| Lu | | | | | | 1.9 (f) |
| Hf | | | | | | 11.7 (f) |
| Ta | | | | | | 1.67 (f) |
| W ppb | | | | | | 160 (f) |
| Re ppb | | | | | | |
| Os ppb | | | | | | |
| Ir ppb | | | | | | |
| Pt ppb | | | | | | |
| Au ppb | | | | | | |
| Th ppm | | | | | | 0.86 (f) |
| U ppm | | | | | | 0.24 (f) |

technique: (a) wet and mixed, (b) IDMS, (c) INAA & RNAA (d) XRF, (e) elec. Probe, (f) ICP-MS

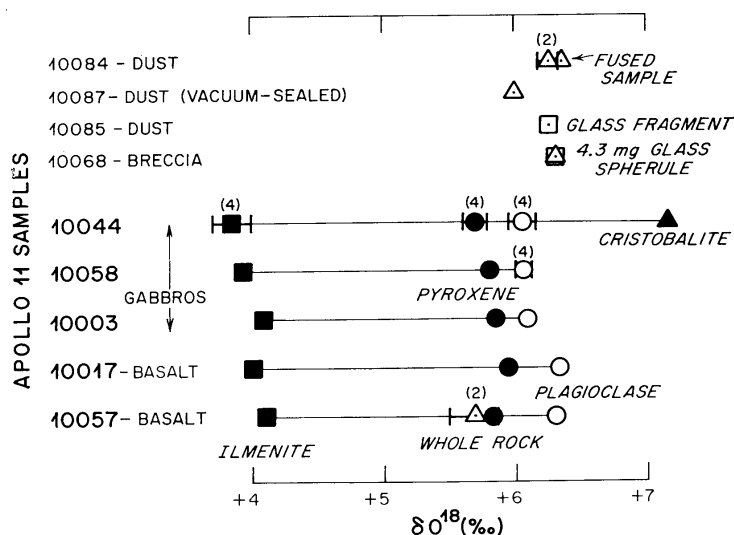

Figure 13: Variation in oxygen isotopes in mineral separates of lunar basalts including 10044 (from Taylor and Epstein 1970).

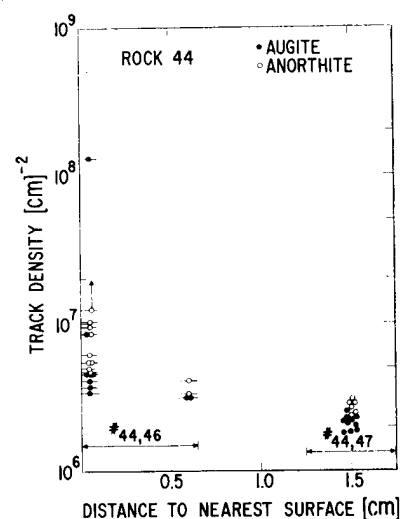

Figure 14: Cosmic ray track density as a function of depth in 10044 (from Fleischer et al. 1970).

Funkhauser et al. (1970), Hohenberg et al. (1970), Hintenberger et al. (1971) and Bogard et al. (1971) reported the abundance and isotopic composition of rare gasses from 10044.

Fleischer et al. (1970) carefully determined the U content and track density in minerals in 10044 (figure 14) and estimated a “proton exposure age” of ~250 m.y.

Processing

Figure 12 shows the external surfaces of 10044. Apollo 11 samples were originally described and cataloged in 1969 and “re-cataloged” by Kramer et al. (1977). There are 18 thin sections.

List of Photo #s for 10044

S69-45538 – 555 B&W mug
 S69-45564 – 581
 S69-59344 TS B&W
 S69-59828 TS
 S70-48950 – 955 TS color
 S70-49981 – 984
 S74-27031 ,54 display
 S75-31691 – 692 ,54 color
 S76-26295 TS
 S76-25541 – 543 color
 S79-27072 – 074 TS

References for 10044

- Agrell S.O., Scoon J.H., Muir I.D., Long J.V.P., McConnell J.D.C. and Peckett A. (1970) Observations on the chemistry, mineralogy and petrology of some Apollo 11 lunar samples. *Proc. Apollo 11 Lunar Sci. Conf.* 93-128.
- Albee A.L. and Chodos A.A. (1970) Microprobe investigations on Apollo 11 samples. *Proc. Apollo 11 Lunar Science Conf.* 135-157.
- Bailey J.C., Champness P.E., Dunham A.C., Esson J., Fyfe W.S., MacKenzie W.S., Stumpfl E.F. and Zussman J. (1970) Mineralogy and petrology of Apollo 11 lunar samples. *Proc. Apollo 11 Lunar Sci. Conf.* 169-194.
- Beaty D.W. and Albee A.L. (1978) Comparative petrology and possible genetic relations among the Apollo 11 basalts. *Proc. 9th Lunar Planet. Sci. Conf.* 359-463.
- Bogard D.D., Funkhouser J.G., Schaeffer O.A. and Zahringer J. (1971) Noble gas abundances in lunar material-cosmic ray spallation products and radiation ages from the Sea of Tranquillity and the Ocean of Storms. *J. Geophys. Res.* **76**, 2757-2779.
- Brown G.M., Emeleus C.H., Holland J.G. and Phillips R. (1970) Mineralogical, chemical, and petrological features of Apollo 11 rocks and their relationship to igneous processes. *Proc. Apollo 11 Lunar Sci. Conf.* 195-219.

- Cameron E.N. (1970) Opaque minerals in certain lunar rocks from Apollo 11. *Proc. Apollo 11 Lunar Sci. Conf.* 221-245.
- Chao E.C.T., James O.B., Minkin J.A., Boreman J.A., Jackson E.D. and Raleigh C.B. (1970) Petrology of unshocked crystalline rocks and evidence of impact metamorphism in Apollo 11 returned lunar samples. *Proc. Apollo 11 Lunar Sci. Conf.* 287-314.
- Davis P.K., Lewis R.S. and Reynolds J.H. (1971) Stepwise heating analysis of rare gases from pile-irradiated rocks 10044 and 10057. *Proc. Second Lunar Sci. Conf.* 1693-1703.
- Dymek R.F., Albee A.L. and Chodos A.A. (1975a) Comparative mineralogy and petrology of Apollo 17 mare basalts: Samples 70215, 71055, 74255, and 75055. *Proc. 6th Lunar Sci. Conf.* 49-77.
- Engel A.E.J. and Engel Celeste G. (1970) Lunar rock compositions and some interpretations. *Proc. Apollo 11 Lunar Sci. Conf.* 1081-1084.
- Engel A.E.J., Engel C.G., Sutton A.L. and Myers A.T. (1971) Composition of five Apollo 11 and Apollo 12 rocks and one Apollo 11 soil and some petrogenetic considerations. *Proc. 2nd Lunar Sci. Conf.* 439-448.
- Fernandez-Moran H., Ohtsuki M., Hafner S.S. and Virgo D. (1970) High voltage electron microscopy and electron diffraction of lunar pyroxenes. *Proc. Apollo 11 Lunar Sci. Conf.* 409-417.
- Fleischer R.L., Haines E.L., Hart H.R., Wood R.T. and Comstock G.M. (1970) The particle track record of the Sea of Tranquillity. *Proc. Apollo 11 Lunar Science Conference* 2103-2120.
- Fuchs L.H. (1970a) Fluorapatite and other accessory minerals in Apollo 11 rocks. *Proc. Apollo 11 Lunar Sci. Conf.* 475-479.
- Funkhauser J.G., Schaeffer O.A., Bogard D.D. and Zahringer J. (1970) Gas analysis of the lunar surface. *Proc. Apollo 11 Lunar Sci. Conf.* 1111-1116.
- Gay P., Bancroft G.M. and Brown M.G. (1970) Diffraction and Mossbauer studies of minerals from lunar soils and rocks. *Proc. Apollo 11 Lunar Sci. Conf.* 481-497.
- Goles G.G., Randle K., Osawa M., Lindstrom D.J., Jerome D.Y., Steinborn T.L., Beyer R.L., Martin M.R. and McKay S.M. (1970) Interpretations and speculations on elemental abundances in lunar samples. *Proc. Apollo 11 Lunar Sci. Conf.* 1177-1194.
- Guggisberg S., Eberhardt P., Geiss J., Grogler N., Stettler A., Brown G.M. and Pecket A. (1979) Classification of the Apollo-11 basalts according to Ar³⁹-Ar⁴⁰ ages and petrological properties. *Proc. 10th Lunar Planet. Sci. Conf.* 1-39.
- Hafner S.S. and Virgo D. (1970) Temperature-dependent cation distributions in lunar and terrestrial pyroxenes. *Proc. Apollo 11 Lunar Sci. Conf.* 2183-2198.
- Hintenberger H., Weber H.W. and Takaoka N. (1971) Concentrations and isotopic abundances of the rare gases in lunar matter. *Proc. 2nd Lunar Sci. Conf.* 1607-1625.
- Hohenberg C.M., Davis P.K., Kaiser W.A., Lewis R.S. and Reynolds J.H. (1970) Trapped and cosmogenic rare gases from stepwise heating of Apollo 11 samples. *Proc. Apollo 11 Lunar Sci. Conf.* 1283-1309.
- James O.B. and Jackson E.D. (1970) Petrology of the Apollo 11 ilmenite basalts. *J. Geophys. Res.* **75**, 5793-5824.
- Kharkar D.P. and Turekian K.K. (1970) Neutron activation analysis of milligram quantities of Apollo 11 lunar rocks and soil. *Proc. Apollo 11 Lunar Sci. Conf.* 1659-1664.
- Kharkar D.P. and Turekian K.K. (1971) Analyses of Apollo 11 and Apollo 12 rocks and soils by neutron activation. *Proc. 2nd Lunar Sci. Conf.* 1301-1305.
- Kramer F.E., Twedell D.B. and Walton W.J.A. (1977) **Apollo 11 Lunar Sample Information Catalogue** (revised). Curator's Office, JSC 12522
- LSPET (1969) Preliminary examination of lunar samples from Apollo 11. *Science* **165**, 1211-1227.
- McGee P.E., Warner J.L. and Simonds C.H. (1977) Introduction to the Apollo Collections. Part I: Lunar Igneous Rocks. Curators Office, JSC.
- Moore C.B., Gibson E.K., Larimer J.W., Lewis C.F. and Nichiporuk W. (1970) Total carbon and nitrogen abundances

- in Apollo 11 lunar samples. *Proc. Apollo 11 Lunar Sci. Conf.* 1375-1382.
- Neal C.R. (2001) Interior of the moon: The presence of garnet in the primitive deep lunar mantle. *J. Geophys. Res.* **106**, 27865-27885.
- Onuma N., Clayton R.N. and Mayeda T. (1970) Apollo 11 rocks: Oxygen isotope fractionation between minerals and an estimate of the temperature of formation. *Proc. Apollo 11 Lunar Sci. Conf.* 1429-1434.
- Papanastassiou D.A., Wasserburg G.J. and Burnett D.S. (1970a) Rb-Sr ages of lunar rocks from the Sea of Tranquillity. *Earth Planet. Sci. Lett.* **8**, 1
- Papanastassiou D.A. and Wasserburg G.J. (1971a) Lunar chronology and evolution from Rb-Sr studies of Apollo 11 and 12 samples. *Earth Planet. Sci. Lett.* **11**, 37-62.
- Philpotts J.A. and Schnetzler C.C. (1970a) Potassium, rubidium, strontium, barium and rare-earth concentrations in lunar rocks and separated phases. *Science* **167**, 493-495.
- Philpotts J.A. and Schnetzler C.C. (1970b) Apollo 11 lunar samples: K, Rb, Sr, Ba and rare-earth concentrations in some rocks and separated phases. *Proc. Apollo 11 Lunar Science Conf.* 1471-1486.
- Reed G.W. and Jovanovic S. (1970) Halogens, mercury, lithium and osmium in Apollo 11 samples. *Proc. Apollo 11 Lunar Sci. Conf.* 1487-1492.
- Rhodes J.M. and Blanchard D.P. (1980) Chemistry of Apollo 11 low-K mare basalts. *Proc. 11th Lunar Planet. Sci. Conf.* 49-66.
- Schmitt H.H., Lofgren G., Swann G.A. and Simmons G. (1970) The Apollo 11 samples: Introduction. *Proc. Apollo 11 Lunar Science Conf.* 1-54.
- Taylor H.P. and Epstein S. (1970a) O18/O16 ratios of Apollo 11 lunar rocks and minerals. *Proc. Apollo 11 Lunar Sci. Conf.* 1613-1626.
- Tera F., Eugster O., Burnett D.S. and Wasserburg G.J. (1970) Comparative study of Li, Na, K, Rb, Cs, Ca, Sr, and Ba abundances in achondrites and in Apollo 11 lunar samples. *Proc. Apollo 11 Lunar Sci. Conf.* 1637-1657.
- Turner G. (1970a) Argon-40/argon-39 dating of lunar rock samples. *Proc. Apollo 11 Lunar Sci. Conf.* 1665-1684.
- Wakita H., Schmitt R.A. and Rey P. (1970) Elemental abundances of major, minor, and trace elements in Apollo 11 lunar rocks, soil, and core samples. *Proc. Apollo 11 Lunar Sci. Conf.* 1685-1717.
- Wänke H., Rieder R., Baddenhausen H., Spettler B., Teschke F., Quijano-Rico M. and Balacescu A. (1970) Major and trace elements in lunar material. *Proc. Apollo 11 Lunar Sci. Conf.* 1719-1727.