

15557
Olivine-normative Basalt
2518 grams



Figure 1: Photo of 15557 showing smooth surface created by micrometeorite bombardment. Sample is 12 cm across. NASA S71-44840.

Introduction

15557 was collected about 40 meters from the edge of Hadley Rille in an area called The Terrace. The lunar regolith was thin in this area, with abundant rock samples (basalts) exposed (Swann et al. 1971). The orientation was documented with surface photography and the top surface is eroded (rounded) by micrometeorites (figure 1). This large sample has not been dated nor properly described (i.e. no mineral analyses).

Petrography

Lunar sample 15557 is a fine-grained olivine-normative basalt with intergranular texture (figure 2). Small (1.5 mm) olivine phenocrysts occur as anhedral crystals

rimmed with pyroxene. Augite and pigeonite occur as discrete grains, but pigeonite is overgrown by augite. The mafic minerals are poikilitically enclosed in plagioclase (up to 1.5 mm). Interstitial phases include cristobalite, ilmenite, ulvospinel, troilite and Fe-metal

Mineralogical Mode for 15557

	Sample Catalog Butler 1971	Nord et al. 1973
Olivine	35 %	10 - 15
Pyroxene	45	50
Plagioclase	50	35
Silica		tr.
Opauques	3	
Mesostasis		5

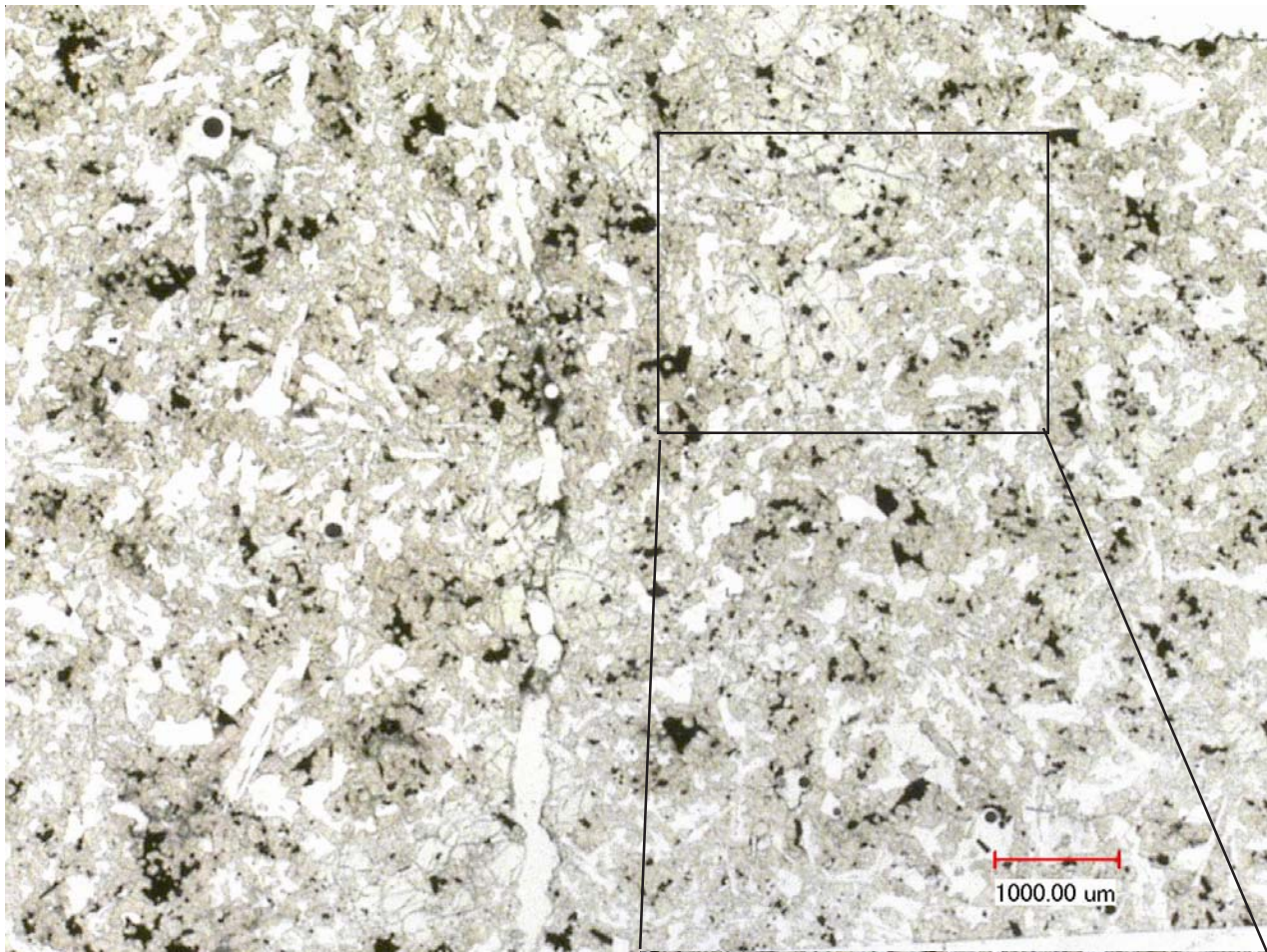

Figure 2a: Photomicrographs of 15557,94 by C Meyer @30x and 100x.

(Nord et al. 1973). There is about 3% void space (figure 6).

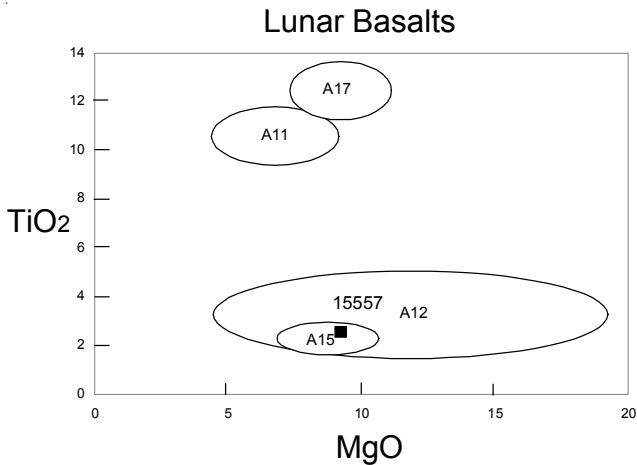
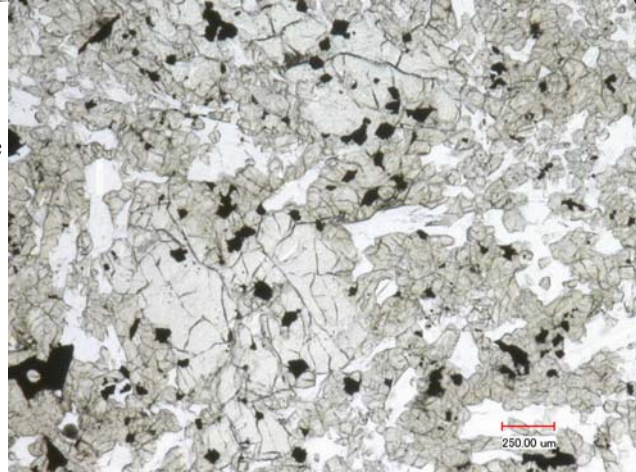

Figure 3: Chemical composition of 15557 compared with other lunar basalts.

Haggerty (1977) remarked on the presence of symplectite in olivine, but it is apparently a minor feature.

Mineralogy

Olivine: Bell et al. (1975) give the composition of the olivine “host” for symplectite.

Pyroxene: no analyses. Nord et al. (1973) report fine exsolution in pyroxene.

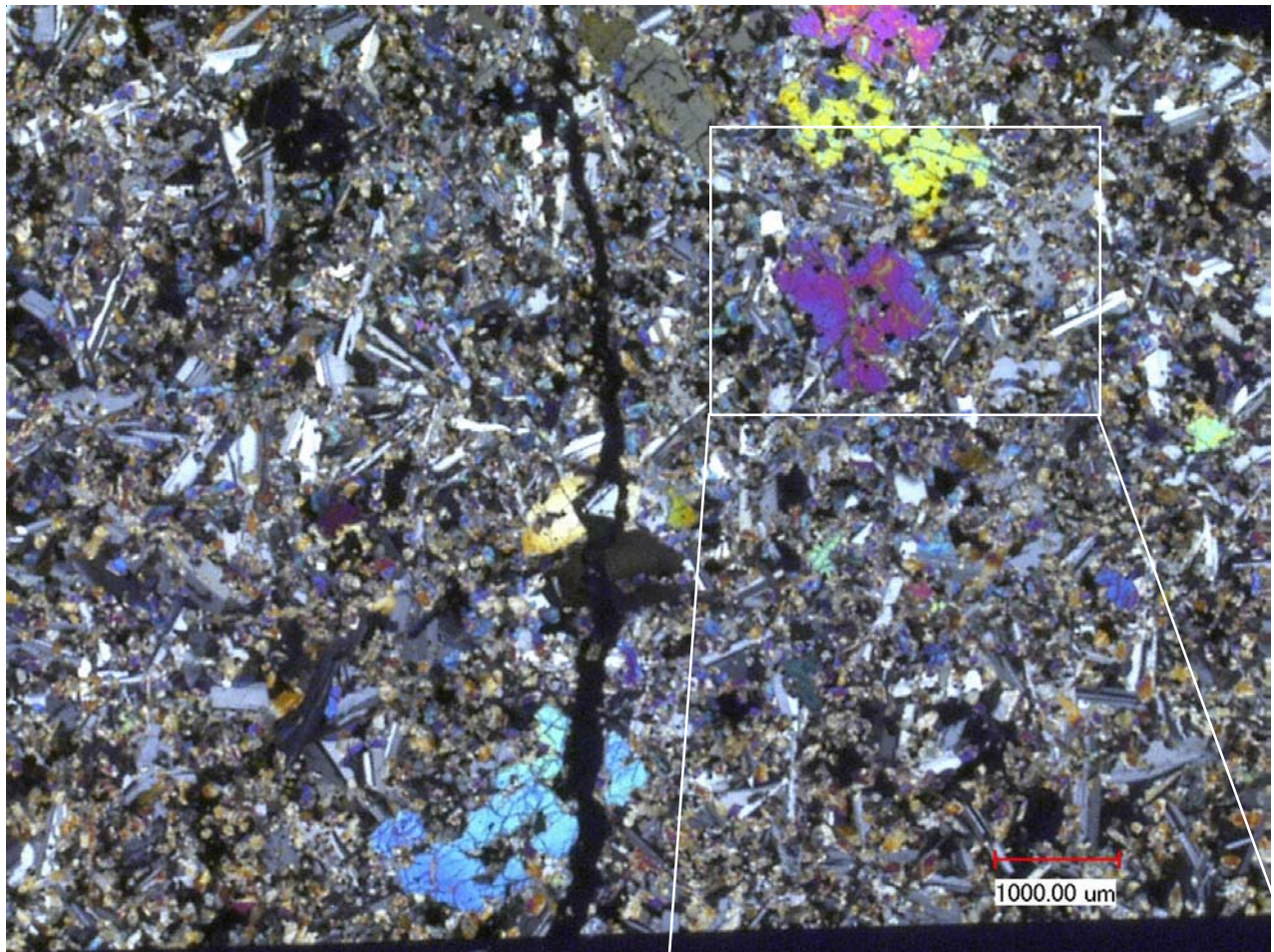

Figure 2b: Photomicrographs of 15557,94 by C Meyer @30x and 100x (with crossed polarizers).

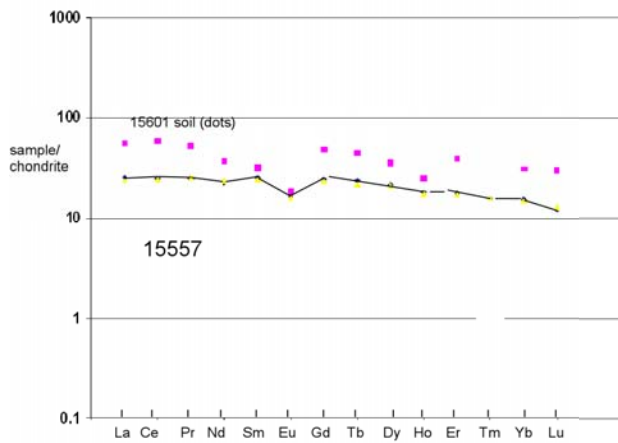
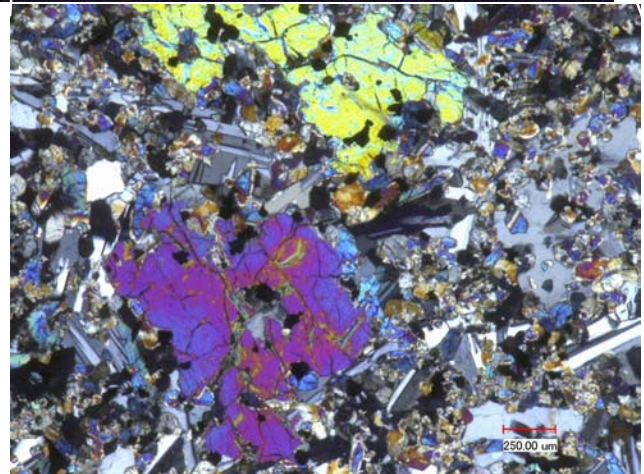

Figure 4: Normalized rare-earth-element composition diagram for 15557 (data by Helmke connected by lines. 15601 for reference).

Chemistry

Ryder et al. (2001) and Neal (2001) appear to have verified the work of earlier chemists (table and figures 4 and 5).

Radiogenic age dating

No determination

Table 1. Chemical composition of 15557.

reference weight	Cuttitta73 Christian72	Baedecker73	Maxwell72	O'Kelley72	Willis 72	Ryder2001	Rancitelli73	Helmke73	Neal2001
SiO2 %	45.74 (a)		45.06 (c)		45.01 (f)	44.8 (f)			
TiO2	2.55 (a)		2.43 (c)		2.53 (f)	2.55 (f)			
Al2O3	8.99 (a)		8.82 (c)		8.84 (f)	9.01 (f)			
FeO	22.35 (a)		22.5 (c)		22.68 (f)	22.02 (f)	21.9 (g)		
MnO	0.28 (a)		0.29 (c)		0.284 (f)	0.284 (f)			
MgO	9.43 (a)		9.52 (c)		9.38 (f)	9.61 (f)			
CaO	10.29 (a)		10.05 (c)		9.99 (f)	9.98 (f)			
Na2O	0.27 (a)		0.34 (c)		0.25 (f)	0.252 (f)	0.26 (g)		
K2O	0.05 (a)		0.04 (c)	0.041 (e)	0.045 (f)	0.044 (f)		0.041 (e)	
P2O5	0.07 (a)		0.07 (c)		0.071 (f)	0.063 (f)			
S %			0.065 (c)		0.09 (f)				
sum									
Sc ppm	37 (a)		48 (d)				45 (g)	43.5 (g)	52.2 (h)
V	185 (a)		240 (d)						316 (h)
Cr	3079 (a)		4584 (d)		3968 (f)	2778 (f)	4320 (g)	4700 (g)	4759 (h)
Co	60 (a)		54 (d)				48.9 (g)		63 (h)
Ni	49 (a)	56 (b)	65 (d)			49 (f)	55 (g)	50 (g)	64 (h)
Cu	14 (a)		13 (d)			11 (f)			19 (h)
Zn		1.3 (b)							21 (h)
Ga	4.9 (a)	4 (b)						3.6 (g)	4.46 (h)
Ge ppb		14 (b)							
As									
Se									
Rb	<1				<2 (f)	3 (f)			1.06 (h)
Sr	105		94 (d)		96.4 (f)	97 (f)	79 (g)		123 (h)
Y	37		25 (d)		24.2 (f)	23 (f)			34.6 (h)
Zr	63		140 (d)		88.4 (f)	85 (f)			116 (h)
Nb	12				6.1 (f)	11 (f)			7.42 (h)
Mo									0.1 (h)
Ru									
Rh									
Pd ppb									
Ag ppb									
Cd ppb		2 (b)							
In ppb		0.5 (b)							
Sn ppb									
Sb ppb									
Te ppb									
Cs ppm								0.035 (g)	0.01 (h)
Ba	40		49 (d)		55 (f)		57 (g)		60.4 (h)
La	22						5.1 (g)	5.77 (g)	5.93 (h)
Ce							15.5 (g)	16.1 (g)	14.9 (h)
Pr									2.24 (h)
Nd							7 (g)	12.1 (g)	10.4 (h)
Sm							3.7 (g)	4.36 (g)	3.72 (h)
Eu							0.91 (g)	1.1 (g)	0.93 (h)
Gd								5.8 (g)	4.78 (h)
Tb							0.79 (g)	0.98 (g)	0.85 (h)
Dy								6.43 (g)	5.18 (h)
Ho								1.3 (g)	1 (h)
Er								3.6 (g)	2.78 (h)
Tm									0.38 (h)
Yb	4.4		4.6 (d)				2.27 (g)	2.64 (g)	2.49 (h)
Lu							0.32 (g)	0.39 (g)	0.29 (h)
Hf							2.62 (g)	2.3 (g)	2.65 (h)
Ta							0.4 (g)		0.48 (h)
W ppb									80 (h)
Re ppb									
Os ppb									
Ir ppb		0.061 (b)							
Pt ppb									
Au ppb		0.084 (b)							
Th ppm				0.45 (e)			0.4 (g)	0.44 (e)	0.34 (h)
U ppm				0.14 (e)				0.131 (e)	0.1 (h)

technique: (a) conventional, (b) RNAA, (c) wet chem., (d) various, (e) radiation counting, (f) XRF, (g) INAA, (h) ICP-MS

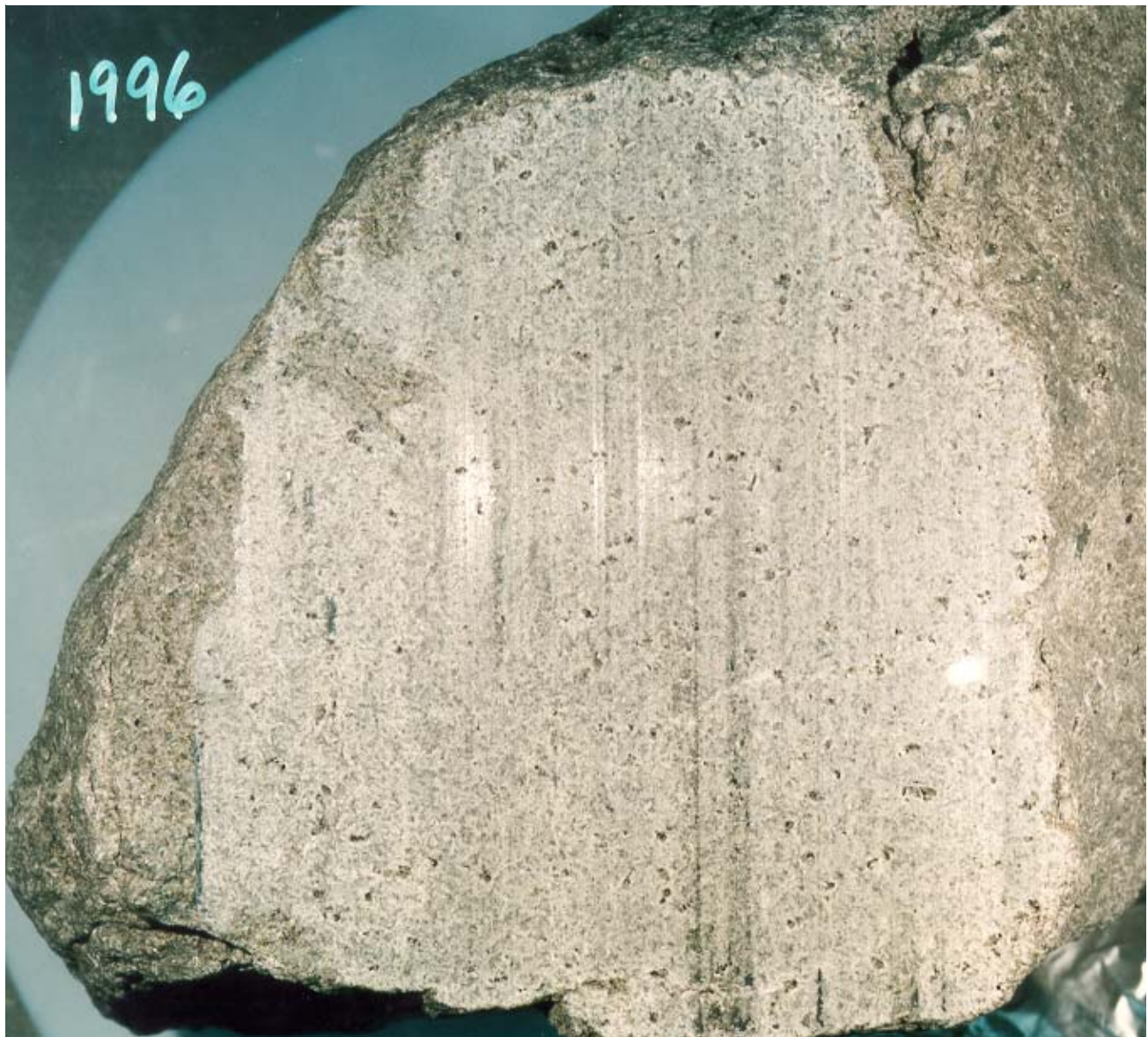

Figure 5: Sawn surface of 15557,0 showing saw marks. NASA S97-16847. This surface is about 7 cm across.

Cosmogenic isotopes and exposure ages

Rancitellit et al. (1972) determined the cosmic-ray-induced activity of $^{22}\text{Na} = 39$ dpm/kg, $^{26}\text{Al} = 75$ dpm/kg, $^{46}\text{Sc} = 3.4$ dpm/kg, and $^{54}\text{Mn} = 34$ dpm/kg.

Other Studies

Thode and Reese (1972) determined the isotopic composition of sulfur. Bhandari et al. (1973) measured the density of solar flare tracks as function of depth.

Processing

A slab was cut through the middle.

There are only 6 thin sections of this large rock.

References for 15557

Baedecker P.A., Chou C.-L., Grudewicz E.B. and Wasson J.T. (1974) Volatile and siderophile trace elements in Apollo 15 samples: Geochemical implications and characterization of the long-lived and short-lived extralunar materials. *Proc. 4th Lunar Sci. Conf.* 1177-1195.

Bell P.M., Mao H.K., Roedder E. and Weiblen P.W. (1975) The problem of the origin of symplectites in olivine-bearing lunar rocks. *Proc. 6th Lunar Sci. Conf.* 231-248.

Bhandari N., Goswami J. and Lal D. (1973) Surface irradiation and evolution of the lunar regolith. *Proc. 4th Lunar Sci. Conf.* 2275-2290.

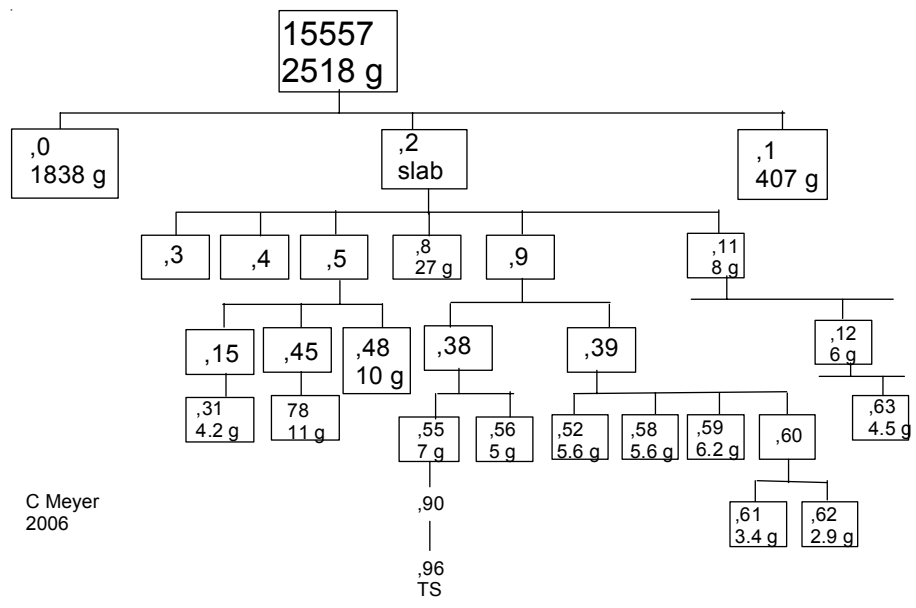
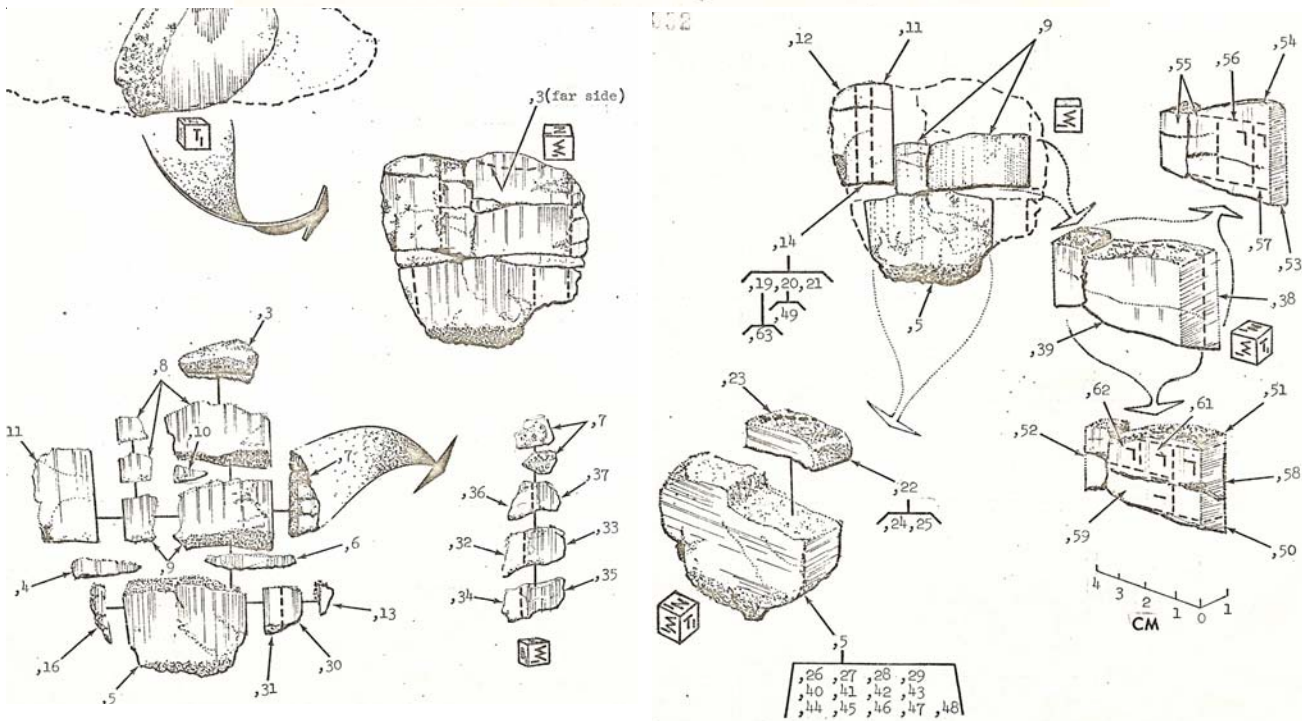
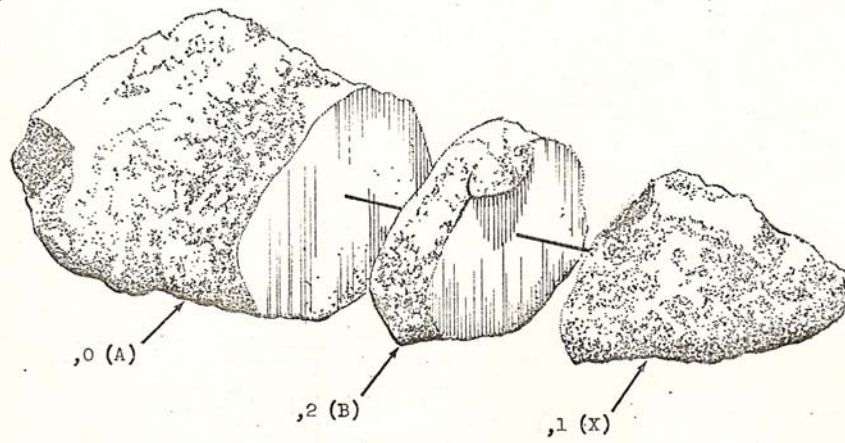

C Meyer
2006

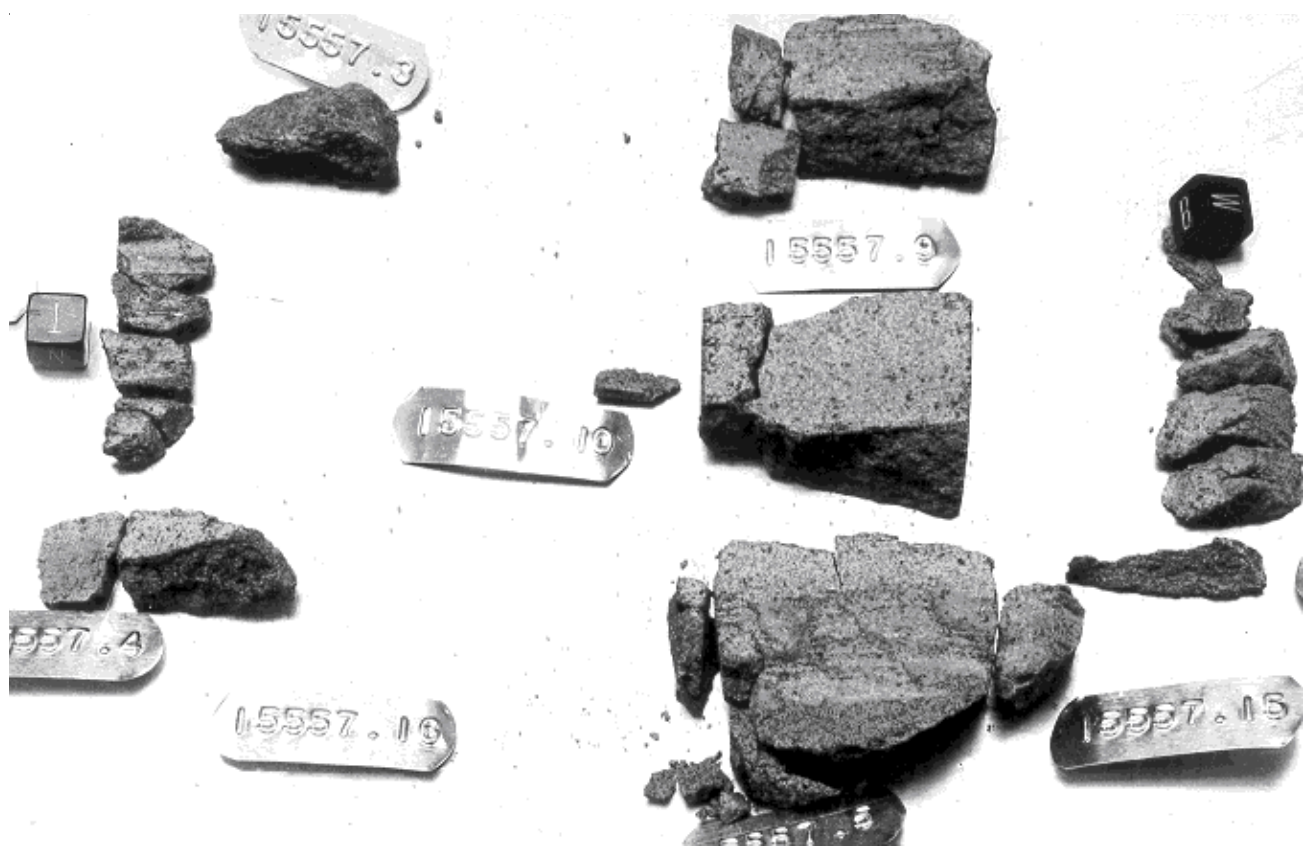
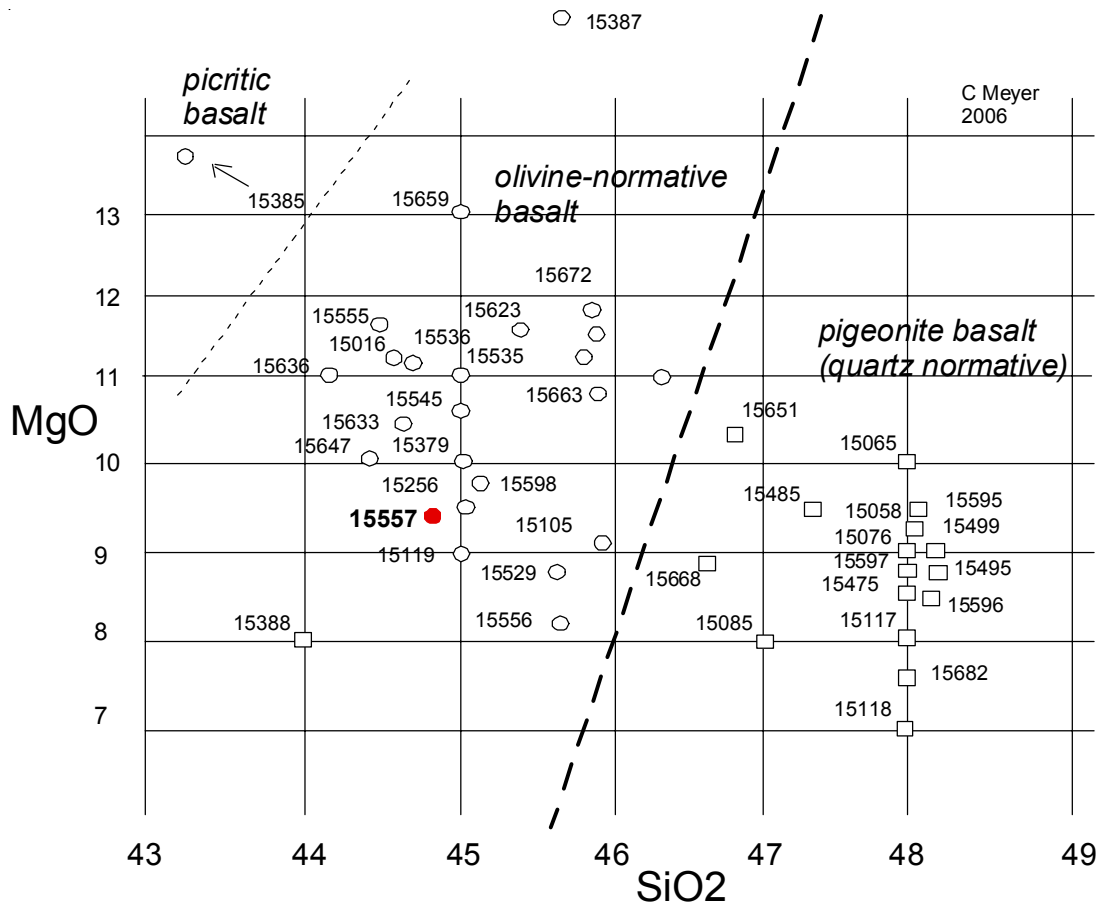

Figure 6: Parts diagram for the slab that was cut from 15557. Largest piece is just over one inch. NASA S72-15057.



- Butler P. (1971) Lunar Sample Catalog, Apollo 15. Curators' Office, MSC 03209
- Carron M.K., Annell C.S., Christian R.P., Cuttitta F., Dwornik E.J., Ligon D.T. and Rose H.J. (1972) Elemental analysis of lunar soil samples from Apollo 15 mission. In **The Apollo 15 Samples** 198-201.
- Cuttitta R., Rose H.J., Annell C.S., Carron M.K., Christian R.P., Ligon D.T., Dwornik E.J., Wright T.L. and Greenland L.P. (1973) Chemistry of twenty-one igneous rocks and soils returned by the Apollo 15 mission. *Proc. 4th Lunar Sci. Conf.* 1081-1096.
- Eldridge J.S., O'Kelley G.D. and Northcutt K.J. (1972) Concentrations of cosmogenic radionuclides in Apollo 15 rocks and soils. In **The Apollo 15 Lunar Samples** 357-359.
- Haggerty S.E. (1977b) Apollo 14: Oxide, metal and olivine mineral chemistries in 14072 with a bearing on the temporal relationships of subsolidus reduction. *Proc. 8th Lunar Sci. Conf.* 1809-1829.
- Helmke P.A., Blanchard D.P., Haskin L.A., Telander K., Weiss C. and Jacobs J.W. (1973) Major and trace elements in igneous rocks from Apollo 15. *The Moon* **8**, 129-148.
- Heuer A.H., Nord G.L., Radcliffe S.V., Fischer R.M., Lally J.S., Christie J.M. and Griggs D.T. (1972) High voltage electron petrographic study of Apollo 15 rocks. In **Apollo 15 Lunar Samples**. 98-102.
- Kothari B.K. and Goel P.S. (1973) Nitrogen in lunar samples. *Proc. 4th Lunar Sci. Conf.* 1587-1596.
- Lofgren G.E., Donaldson C.H. and Usselman T.M. (1975) Geology, petrology and crystallization of Apollo 15 quartz-normative basalts. *Proc. 6th Lunar Sci. Conf.* 79-99.
- LSPET (1972a) The Apollo 15 lunar samples: A preliminary description. *Science* **175**, 363-375.
- LSPET (1972b) Preliminary examination of lunar samples. Apollo 15 Preliminary Science Report. NASA SP-289, 6-1—6-28.
- Maxwell J.A., Bouvier J.-L. and Wiik H.B. (1972) Chemical composition of some Apollo 15 lunar samples. In **The Apollo 15 Lunar Samples**, 233-238.
- Neal C.R. (2001) Interior of the moon: The presence of garnet in the primitive deep lunar mantle. *J. Geophys. Res.* **106**, 27865-27885.
- Nord G.L., Lally J.S., Heuer A.H., Christie J.M., Radcliffe S.V., Griggs D.T. and Fisher R.M. (1973) Petrologic study of igneous and metaigneous rocks from Apollo 15 and 16 using high voltage transmission electron microscopy. *Proc. 4th Lunar Sci. Conf.* 953-970.
- O'Kelley G.D., Eldridge J.S. and Northcutt K.J. (1972a) Abundances of primordial radioelements K, Th, and U in Apollo 15 samples, as determined by non-destructive gamma-ray spectrometry. In **The Apollo 15 Lunar Samples**, 244-246.
- O'Kelley G.D., Eldridge J.S., Schonfeld E. and Northcutt K.J. (1972b) Primordial radionuclides and cosmogenic radionuclides in lunar samples from Apollo 15. *Science* **175**, 440-443.
- Rancitelli L.A., Perkins R.W., Felix W.D. and Wogman N.A. (1972) Lunar surface processes and cosmic ray characterization from Apollo 12-15 lunar samples analyses. *Proc. 3rd Lunar Sci. Conf.* 1681-1691.
- Ryder G. (1985) Catalog of Apollo 15 Rocks (three volumes). Curatorial Branch Pub. # 72, JSC#20787
- Ryder G. and Schuraytz B.C. (2001) Chemical variations of the large Apollo 15 olivine-normative mare basalt rock samples. *J. Geophys. Res.* **106**, E1, 1435-1451.
- Swann G.A., Hait M.H., Schaber G.C., Freeman V.L., Ulrich G.E., Wolfe E.W., Reed V.S. and Sutton R.L. (1971b) Preliminary description of Apollo 15 sample environments. U.S.G.S. Interagency report: 36. pp219 with maps
- Swann G.A., Bailey N.G., Batson R.M., Freeman V.L., Hait M.H., Head J.W., Holt H.E., Howard K.A., Irwin J.B., Larson K.B., Muehlberger W.R., Reed V.S., Rennilson J.J., Schaber G.G., Scott D.R., Silver L.T., Sutton R.L., Ulrich G.E., Wilshire H.G. and Wolfe E.W. (1972) 5. Preliminary Geologic Investigation of the Apollo 15 landing site. In Apollo 15 Preliminary Science Rpt. NASA SP-289. pages 5-1-112.
- Thode H.G. and Rees C.E. (1972) Sulphur concentrations and isotope ratios in Apollo 14 and 15 samples. In **The Apollo 15 Lunar Samples**, 402-403.
- Willis J.P., Erlank A.J., Gurney J.J. and Ahrens L.H. (1972) Geochemical features of Apollo 15 materials. In **The Apollo 15 Lunar Samples**, 268-271.