

74275
Oriented Ilmenite Basalt
1493 grams

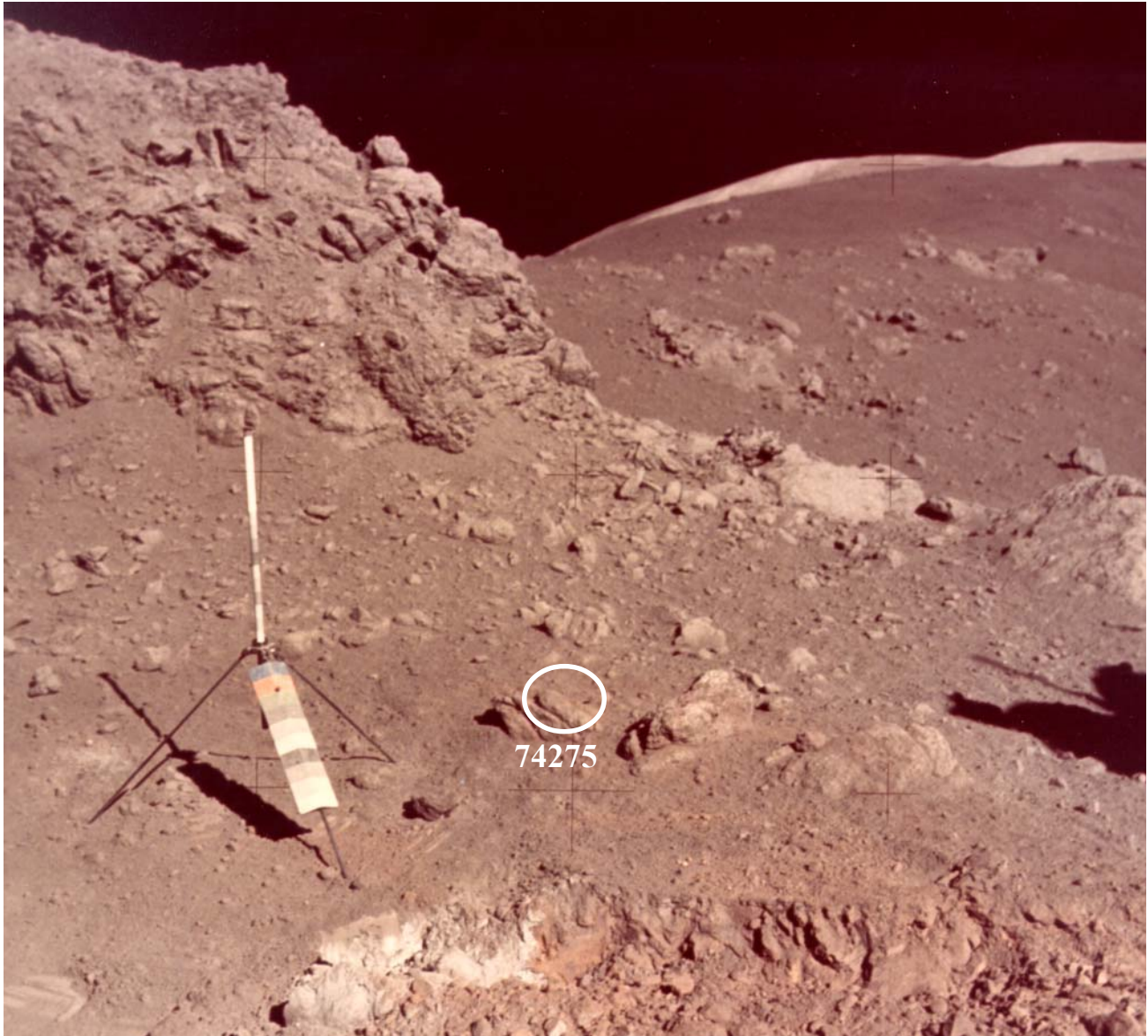

Figure 1: Location of basalt sample 74275 at Shorty Crater - also see 74220. (false color) AS17-137-20990

Introduction

74275 is a fine-grained, high-Ti mare basalt with significant armalcolite content (Hodges and Kushiro 1974; Neal and Taylor 1993). It contains vesicles, vugs and unusual olivine megacrysts (Fo_{82}) (Meyer and Wilshire 1974).

74275 was collected from the rim of Shorty Crater (figure 1) and was photographed both on the lunar surface and in the laboratory (with similar lighting) to document the exact lunar orientation. (Wolfe et al.

1981). This sample has proven useful to studies that require known lunar orientation with extended exposure history to the extra-lunar environment (micrometeorites, cosmic rays, solar irradiation). The sample is relatively flat 17 by 12 cm and 4 cm thick. The top (T1) surface is somewhat rounded and has many micrometeorite pits (figure 4), while the bottom (B1) surface is flat and angular and without any evidence of exposure to the micrometeorites (figure 5). Fink et al. (1998) have carefully considered the exact orientation (30 deg tilt), shielding (nearby

boulder) and detailed exposure history (complex) of 74275.

This basalt has been determined to be very old (> 3.8 b.y.). Based on trace element analysis it is a type C Apollo 17 basalt.

Petrography

Perhaps the best petrographic description of 74275 is given by Hodges and Kushiro (1974): “Rock 74275 is a fine-grained ilmenite basalt with microphenocrysts of olivine (Fo80-71), titanaugite (up to 6.8 wt. % TiO₂) and armalcolite rimmed with ilmenite set in a subvariolic groundmass of clinopyroxene, plagioclase (An88-78), ilmenite, tridymite, metallic iron (Ni<1 wt.%), troilite and glass. Spinel occurs only within olivine grains.”

Neal and Taylor (1993) and Brown et al. (1975) compare 74275 with a suite of high-Ti basalts from Apollo 17. 74275 contains groundmass plagioclase, pyroxene and ilmenite with larger crystals of pink pyroxene (up to 0.5 mm) and olivine (up to 0.7 mm) and ilmenite/armalcolite laths (up to 0.7 mm in length) (figure 6). Pyroxene rims are present on some olivine phenocrysts. Minor blebs of iron metal and troilite are found in the mesostasis. Olivine megacrysts (figure 8), some termed “dunite inclusions”, are common in 74275 (Meyer and Wilshire 1974). These can be seen as green inclusions in the photo of the bottom surface (figure 5).

Mineralogy

Pyroxene: The pyroxenes in 74275 are high Ca pyroxene without the presence of low-Ca pyroxene (figure 2). Sung et al. (1974) have shown that the pyroxenes in 74275 contain high concentrations of Ti³⁺.

Olivine: Delano and Lindsley (1982) have carefully considered the olivine in 74275 (figure 7). The olivine megacrysts in 74275 are too magnesium rich to have formed from the melt (Meyer and Wilshire 1974). Unusual olivine with an “hourglass” structure has been reported by Hodges and Kushiro (1974).

Opaques: Armalcolite is rimmed with ilmenite (Hodges and Kushiro 1974; El Goresy et al. 1974). Small euhedral chromite are found as inclusions in the olivine clusters (Neal and Taylor 1993).

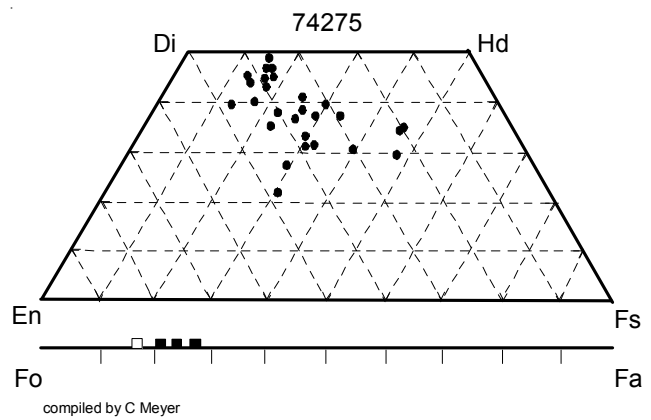

Figure 2: Composition of pyroxene and olivine in 74275 (replotted from Hodges and Kushiro 1974, with apologies). The open symbol at Fo₈₂₋₈₄ represents the composition of olivine xenocrysts (Delano and Lindsley 1982).

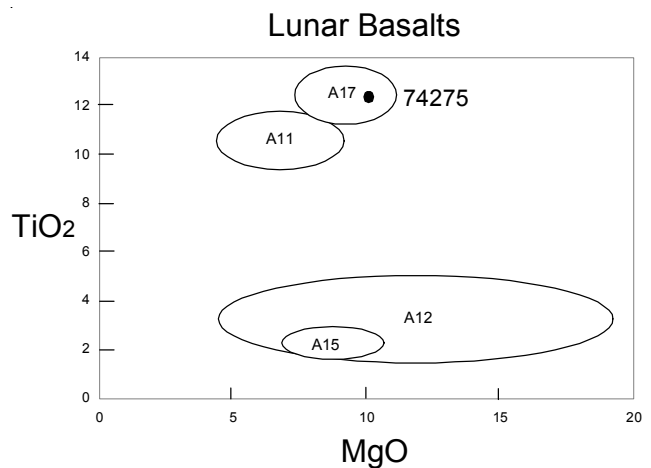

Figure 3: Chemical composition of Apollo basalts with 74275.

Chemistry

The chemical composition of 74275 has been determined by Duncan et al. (1974), Wanke et al. (1974), Rose et al. (1975) and other (table 1). Trace elements have been determined by Rhodes et al. (1976), Wanke et al. (1974) and others (table 1, figure 9). 75275 is a type C, Apollo 17 basalt (figure 10) (Paces et al. 1991). Dickinson et al. (1989) determined Ge. Gibson and Moore (1974) reported 1650 ppm S.

Mineralogical Mode for 74275

| | Brown et Meyer and al. 1975 | Wilshire 1974 |
|-------------|-----------------------------|---------------|
| Olivine | 13 % | 16.1 |
| Pyroxene | 36 | 34.9 |
| Opaques | 31 | 33.3 |
| Plagioclase | 19 | 15.6 |



Figure 4: Top surface of 74275 showing numerous micrometeorite “zap” pits. NASA# S73-16018. Cube is 1 cm.



Figure 5: Bottom surface of 74275 showing vesicles and vugs. NASA# S73-16019 (faded). Cube is 1 cm.



Figure 6: Photomicrograph of thin section of 74275 (from Neal and Taylor 1993).

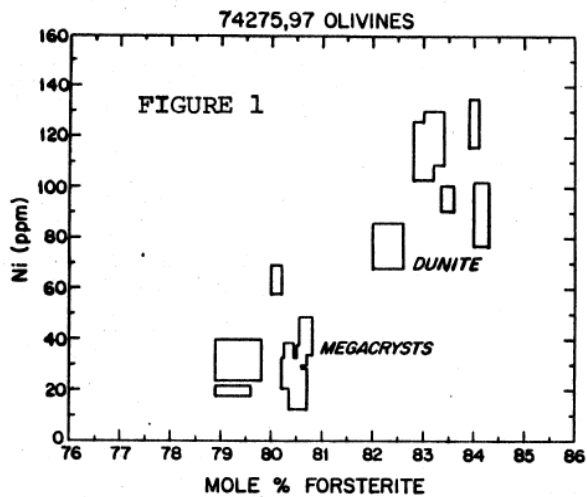

Figure 7: Ni and Mg in olivine in 74275 (from Delano and Lindsley 1982).

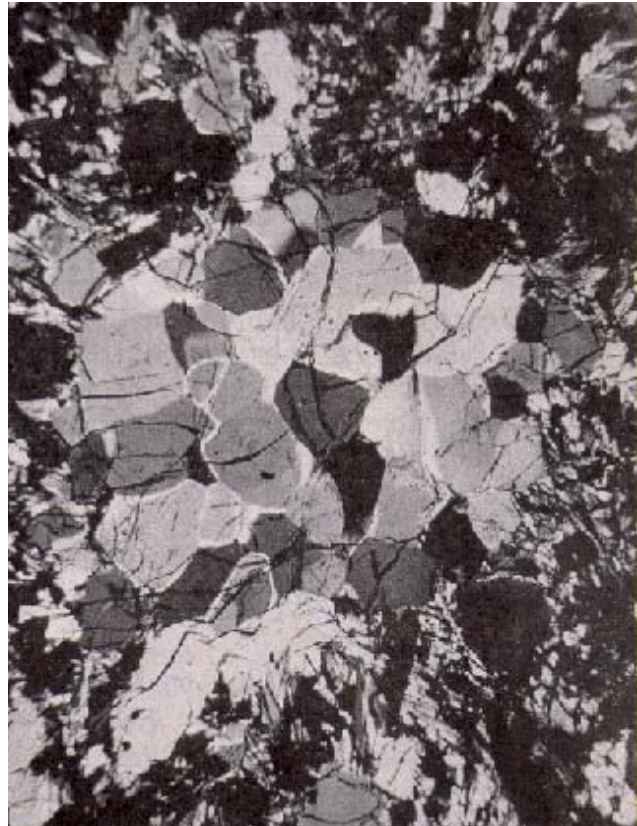

Figure 8: Photomicrograph of "dunite" inclusion in 74275 (from Delano and Lindsley 1982).

Gibson (1987), Petrowski et al. (1974), Reese and Thode (1974) and Des Marais (1980) determined S, C, N and H. Garg and Ehman (1976) and Hughes and Schmitt (1985) determined Zr and Hf.

Halogens, Hg and Li have been determined by Jovanovic and Reed (1974).

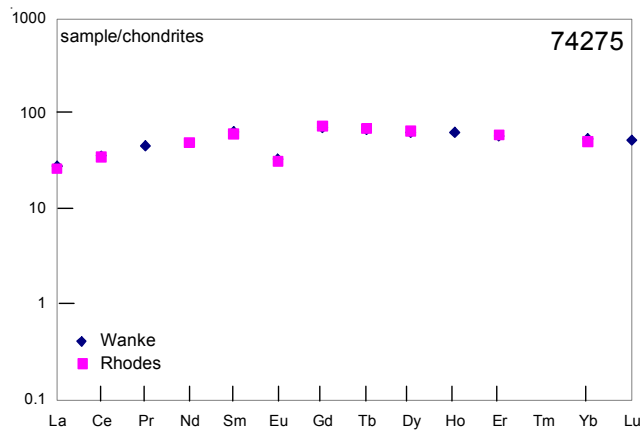

Figure 9: Normalized rare-earth-element diagram for 74275 (data from Wanke et al. 1974, Rhodes et al. 1976).

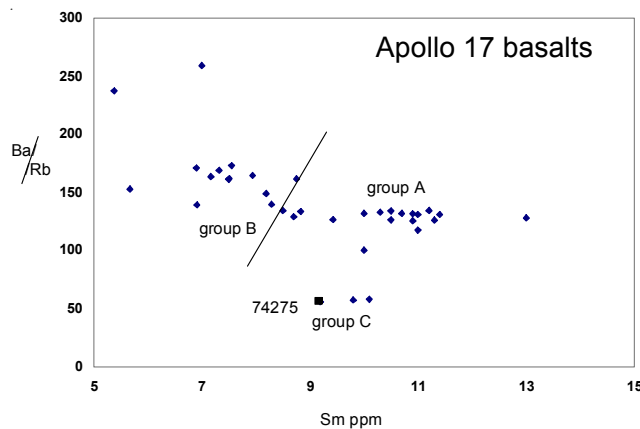

Figure 10: Trace element characterization of Apollo 17 basalts showing 74275 is type C.

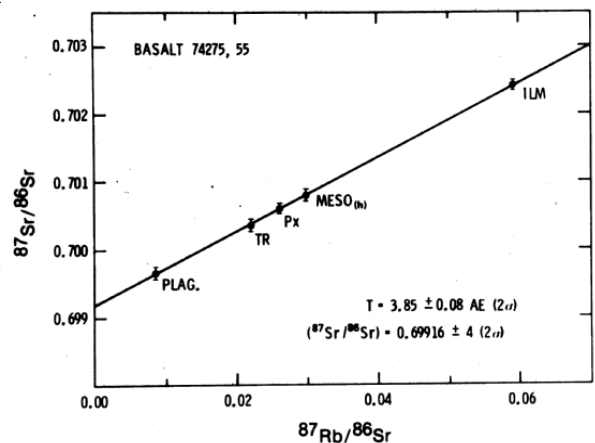

Figure 11: Rb-Sr isochron for 74275 (from Murthy and Coscio 1977).

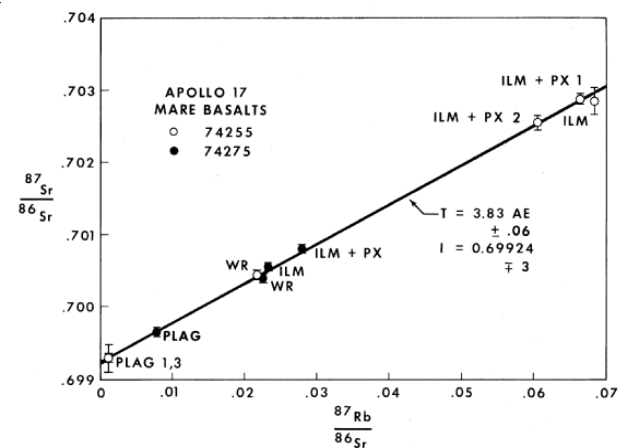

Figure 12: Rb-Sr isochron for 74255 with added data from 74275 (from Nyquist et al. 1976). The isochron fit for 74275 is 3.81 +/- 0.32 b.y.

Radiogenic age dating

Murthy and Coscio (1977) dated 74275 at 3.85 ± 0.08 b.y. using Rb-Sr (figure 11). Nyquist et al. (1976) obtained an age of 3.81 ± 0.32 b.y. (figure 12). Nunes et al. (1974) and Paces et al. (1991) determined whole rock U-Th-Pb and Sm-Nd isotopics, respectively.

Summary of age dating 74275

| | Rb/Sr |
|------------------------|-----------------|
| Murthy and Coscio 1977 | 3.85 ± 0.08 |
| Nyquist et al. 1976 | 3.81 ± 0.32 |
| Nunes et al. 1974 | |

Caution: Old decay constants.

Cosmogenic isotopes and exposure ages

Goswami and Lal (1974) determined a SUNTAN exposure age of 2.8 m.y. from the density and gradient of nuclear tracks caused by very heavy cosmic ray

bombardment and this was initially thought to be the age of Shorty crater. Eugster et al. (1977) measured the isotopic ratio of all the rare gases and determined an “exposure age” of 32.2 ± 1.4 m.y. by the ^{81}Kr -Kr method for 74275. However, the age of Shorty crater (~19 m.y.) was determined from the samples of a nearby boulder, thus sample 74275 is thought to have had a complicated exposure history. Crozaz (1978), Arvidson et al. (1975) and Eberhardt et al. (1974) have also discussed the exposure age of 74275 and its relationship to the age of Shorty Crater.

Fruchter et al. (1982), Klein et al. (1990) and Fink et al. (1998) have reported precise depth profiles of the cosmogenic radionuclides ^{10}Be , ^{22}Na , ^{26}Al and ^{41}Ca (figures 14-17) and modeled the flux and energy of cosmic rays. The ^{22}Na activity is residual from the 1972 solar flare event (Sisterson and Reedy 1997).

Table 1. Chemical composition of 74275.

| reference weight | Duncan74 | Rose 75 | Rhodes76 | Wanke 74 | Murthy77 | Miller 74 recalculated | Hodges74 | Green75 | Brunfelt74 |
|------------------|----------|-----------|-------------|----------|----------|---------------------------|--------------------|----------|--------------|
| SiO2 % | 38.43 | (a) 38.44 | (a) - - - - | 38.73 | | 38.3 39.58 | (c) 38.4 | (d) 37.9 | (d) |
| TiO2 | 12.66 | (a) 12.75 | (a) | 11.71 | | 11.88 8.75 | 14.1 | (d) 12.6 | (d) 13.1 (c) |
| Al2O3 | 8.51 | (a) 8.93 | (a) | 8.4 | | 8.51 9.07 | 8.5 | (d) 8.3 | (d) 8.83 (c) |
| FeO | 18.25 | (a) 18.03 | (a) | 18.29 | | 18.31 18.18 | 17.4 | (d) 19.1 | (d) 18 (c) |
| MnO | 0.247 | (a) 0.27 | (a) | 0.241 | | 0.25 0.25 | 0.35 | (d) 0.2 | (d) 0.25 (c) |
| MgO | 10.26 | (a) 10.46 | (a) | 10.16 | | 10.47 10.14 | 8.6 | (d) 10.4 | (d) 10.8 (c) |
| CaO | 10.38 | (a) 10.26 | (a) | 10.08 | | 10.36 10.08 | 10.7 | (d) 10.2 | (d) 11.3 (c) |
| Na2O | 0.37 | (a) 0.33 | (a) | 0.37 | | 0.38 0.39 | 0.22 | (d) 0.4 | (d) 0.34 (c) |
| K2O | 0.075 | (a) 0.09 | (a) | 0.08 | 0.04 | (b) | 0.07 | (d) 0.1 | (d) 0.07 (c) |
| P2O5 | 0.074 | (a) 0.06 | (a) Gibson | 0.063 | | | | | |
| S % | 0.141 | (a) | | 0.14 | | | | | |
| sum | | | | | | | | | |
| Sc ppm | | 78 | (a) | 74 | (c) | | | | 83 (c) |
| V | 79 | (a) 62 | (a) | | | | | | 146 (c) |
| Cr | 4372 | (a) 4447 | (a) | 3688 | (c) | | | | 4100 (c) |
| Co | 24 | (a) 31 | (a) | 22.5 | (c) | | | | 21.3 (c) |
| Ni | <3 | (a) 16 | (a) | - | | | | | <10 (c) |
| Cu | | 40 | (a) | 3.5 | (c) | | | | 3.3 (c) |
| Zn | | 5.8 | (a) | 1.7 | (c) | | | | 2 (c) |
| Ga | | 6.2 | (a) | 3.4 | (c) | | Dickinson 89 | | 4.1 (c) |
| Ge ppb | | | | | | | 6.8 | | |
| As ppb | | | | 4 | (c) | | | | |
| Se | | | | | | | Nyquist 76Paces 91 | | |
| Rb | 1.9 | (a) | | 1.2 | (b) 1.22 | (c) 1.03 | (b) 1.2 0.864 | | 0.9 (c) |
| Sr | 158 | (a) 152 | (a) 153 | (b) 195 | (c) 135 | (b) 153 | 116 | | 115 (c) |
| Y | 81.5 | (a) 116 | (a) | 79 | (c) | | Hughes 85 | | |
| Zr | 248 | (a) 290 | (a) | 246 | (c) | | 261 | | |
| Nb | 22.1 | (a) | | 19 | (c) | | | | |
| Mo | | | | | | | | | |
| Ru | | | | | | | | | |
| Rh | | | | | | | | | |
| Pd ppb | | | | | | | | | |
| Ag ppb | | | | | | | | | |
| Cd ppb | | | | | | | | | |
| In ppb | | | | | | | | | |
| Sn ppb | | | | | | | | | |
| Sb ppb | | | | | | | | | |
| Te ppb | | | | | | | | | |
| Cs ppm | | | | 53 | (c) | | | | 60 (c) |
| Ba | 89 | (a) | | 67.3 | (b) 83 | (c) 73.8 | (b) | | 65 (c) |
| La | | | | 6.33 | (b) 6.7 | (c) | | | 5.98 (c) |
| Ce | | | | 21.4 | (b) 22.1 | (c) | | | 16.5 (c) |
| Pr | | | | | 4.2 | (c) | | | |
| Nd | | | | 22.8 | (b) | | 22.5 | | |
| Sm | | | | 9.19 | (b) 9.76 | (c) | 9.24 | | 9.7 (c) |
| Eu | | | | 1.8 | (b) 1.91 | (c) | | | 1.93 (c) |
| Gd | | | | 14.8 | (b) 14.2 | (c) | | | |
| Tb | | | | | 2.5 | (c) | | | 2.05 (c) |
| Dy | | | | 16.3 | (b) 15.8 | (c) | | | 17.9 (c) |
| Ho | | | | | 3.6 | (c) | | | |
| Er | | | | 9.66 | (b) 9.4 | (c) | | | |
| Tm | | | | | | | | | |
| Yb | | 11 | | 8.47 | (b) 9.02 | (c) | | | 7.5 (c) |
| Lu | | | | | 1.3 | (c) | | | 1.34 (c) |
| Hf | | | | | 8.33 | (c) | | | 8.3 (c) |
| Ta | | | | | 1.5 | (c) | | | 1.57 (c) |
| W ppb | | | | | 60 | (c) | | | 99 (c) |
| Re ppb | | | | | <0.5 | (c) | | | |
| Os ppb | | | | | | | | | |
| Ir ppb | | | | | | | | | |
| Pt ppb | | | | | | | | | |
| Au ppb | | | | 0.19 | (c) | | | | |
| Th ppm | | | | | | | Nunes 74 | | |
| U ppm | | | | 0.16 | (c) | | 0.4654 | (b) | 0.38 (c) |
| | | | | | | | 0.136 | (b) | 0.131 (c) |

technique (a) XRF, (b) IDMS, (c) INAA, (d) fused bead, etc. Probe

Table 1b. Chemical composition of 74275 (cont.).

| reference | Neal2001 | Garg76 | | |
|---------------------------------------|----------|--------|------|----------|
| <i>weight</i> | | | | |
| SiO ₂ % | | | | |
| TiO ₂ | | | | |
| Al ₂ O ₃ | | | | |
| FeO | | | | |
| MnO | | | | |
| MgO | | | | |
| CaO | | | | |
| Na ₂ O | | | | |
| K ₂ O | | | | |
| P ₂ O ₅ | | | | |
| S % | | | | |
| <i>sum</i> | | | | |
| Sc ppm | 66 | (a) | | |
| V | 103 | (a) | | |
| Cr | 3303 | (a) | | |
| Co | 21 | (a) | | |
| Ni | 4.78 | (a) | | |
| Cu | 49 | (a) | | |
| Zn | 74 | (a) | | |
| Ga | 2.97 | (a) | | |
| <i>Ge ppb</i> | | | | |
| <i>As ppb</i> | | | | |
| <i>Se</i> | | | | |
| Rb | 1.4 | (a) | | |
| Sr | 141 | (a) | | |
| Y | 83 | (a) | | |
| Zr | 200 | (a) | 270 | 341 (b) |
| Nb | 19.5 | (a) | | |
| Mo | 0.02 | (a) | | |
| <i>Ru</i> | | | | |
| <i>Rh</i> | | | | |
| <i>Pd ppb</i> | | | | |
| <i>Ag ppb</i> | | | | |
| <i>Cd ppb</i> | | | | |
| <i>In ppb</i> | | | | |
| <i>Sn ppb</i> | | | | |
| <i>Sb ppb</i> | | | | |
| <i>Te ppb</i> | | | | |
| Cs ppm | 0.02 | (a) | | |
| Ba | 66 | (a) | | |
| La | 5.78 | (a) | | |
| Ce | 22.8 | (a) | | |
| Pr | 4.32 | (a) | | |
| Nd | 24.3 | (a) | | |
| Sm | 10.1 | (a) | | |
| Eu | 1.81 | (a) | | |
| Gd | 14.5 | (a) | | |
| Tb | 2.57 | (a) | | |
| Dy | 17 | (a) | | |
| Ho | 3.49 | (a) | | |
| Er | 10.3 | (a) | | |
| Tm | 1.39 | (a) | | |
| Yb | 9.17 | (a) | | |
| Lu | 1.2 | (a) | | |
| Hf | 8.96 | (a) | 8.66 | 8.55 (b) |
| Ta | 1.5 | (a) | | |
| <i>W ppb</i> | | | | |
| <i>Re ppb</i> | | | | |
| <i>Os ppb</i> | | | | |
| <i>Ir ppb</i> | | | | |
| <i>Pt ppb</i> | | | | |
| <i>Au ppb</i> | | | | |
| Th ppm | 0.47 | (a) | | |
| U ppm | 0.12 | (a) | | |
| <i>technique (a) ICP-MS, (b) INAA</i> | | | | |

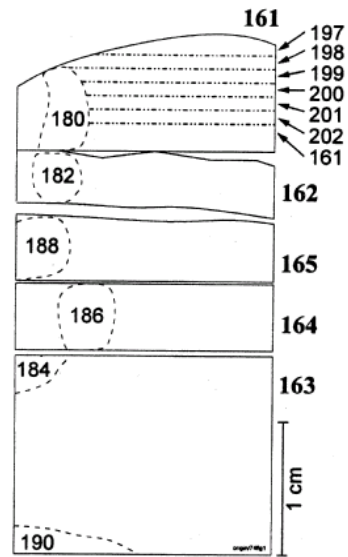

Figure 13: Schematic drawing of column cut from 74275 for study of cosmogenic radionuclide production from energetic solar cosmic ray (from Fink et al. 1998).

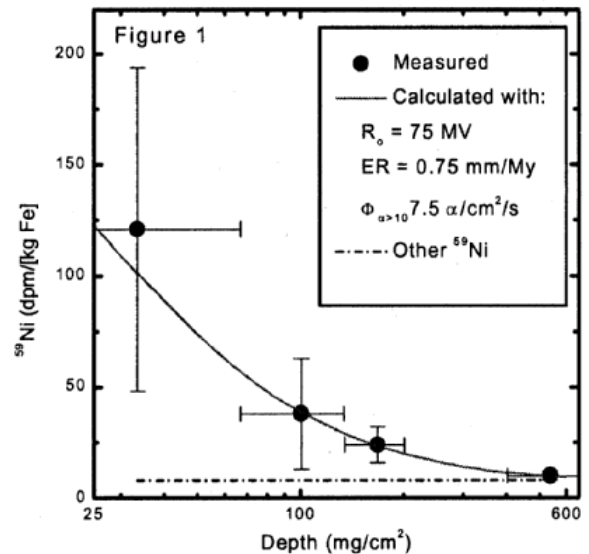

Figure 14: Ni 59 depth profile of very surface of 74275 (from Schnabel et al. 2000) due to irradiation by solar alpha particles.

Schnabel et al. (2000) used accelerator mass spectroscopy to determine a depth profile for ^{59}Ni , produced by SCR alpha particles in the very surface layer (figure 14). However, the erosion rate due to micrometeorite bombardment remains unknown for this sample.

Other Studies

74275 is one of the most Mg rich of the high-Ti Apollo samples, and for this reason the composition of 74275 became the starting point for high-pressure phase-relation experiments (figure 18) aimed at determining the depth of origin of high-Ti mare basalt (Green et al. 1974, 1975; Walker et al. 1976; Delano and Lindsey 1982). However, 74275 contains olivine inclusions that are too mg* to have crystallized from the melt they are in, and the bulk composition of 74275 may not represent the composition of a true melt.

Additional experiments on 74275 include element partitioning between phases (Irving et al. 1978), cooling rate and nucleation (Usselman and Lofgren 1976) and the effects of oxygen fugacity and stability of armalcolite (O'Hara and Humphries 1975; Satan and Taylor 1979).

The magnetic properties of 74275 have been studied by Brecher et al. (1974); Pearce et al. (1974); and Nagata et al. (1975).

Mizutani and Osako (1974) determined the compressional and shear wave velocity as a function of pressure using a sample of 74275.

Processing

Two partial slabs and two columns (4 cm deep) were cut from this sample. The first partial slab (,13 to ,34) was cut in 1973 (figures 19 and 20). A second slab (,166 and ,167) and a column (,161 top; to ,165 middle) was cut in 1981 (figure 21). A second column was cut from ,166 in 1998 (figure 22). Apparently the big piece ,2 broke in storage. A well-documented surface piece ,159 can be identified in the center of the top surface. There are 19 thin sections.

List of Photos # for 74275

S73-16018 to 16024 Color PET
 S73-19156 to 19171 B&W PET
 S81-34492 to 34494
 S98-02167 to 02174

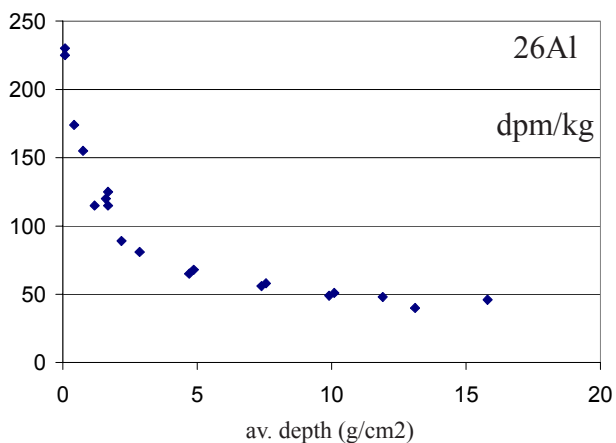

Figure 15: Al 26 depth profile for 74275 (from data by Fruchter et al. (1982); Klein et al (1988); Fink et al. (1998).

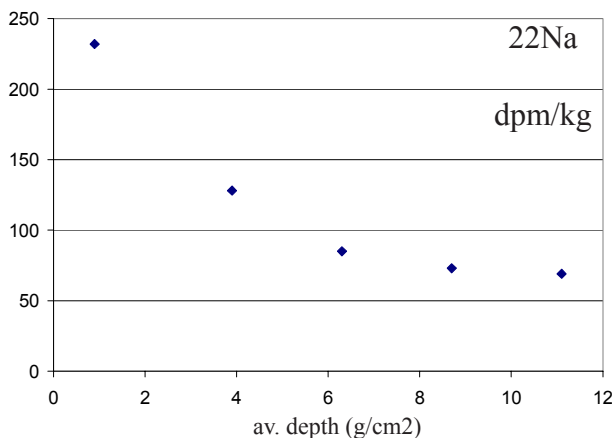

Figure 16: Na 22 depth profile for 74275 (from data by Fruchter et al. (1982) due to irradiation by 1972 solar flare (Sisterson and Reedy 1997).

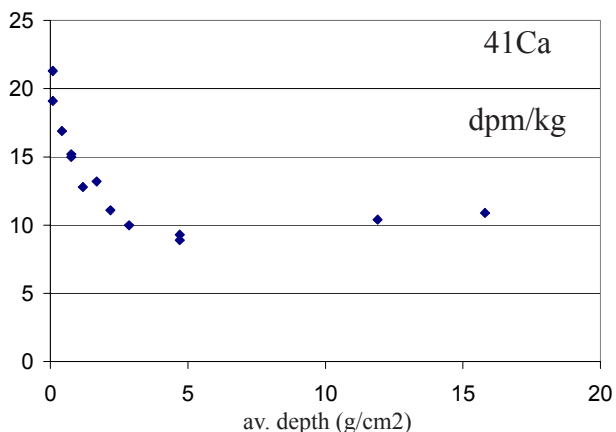

Figure 17: Ca 41 depth profile for 74275 (from data by Fink et al. 1998).

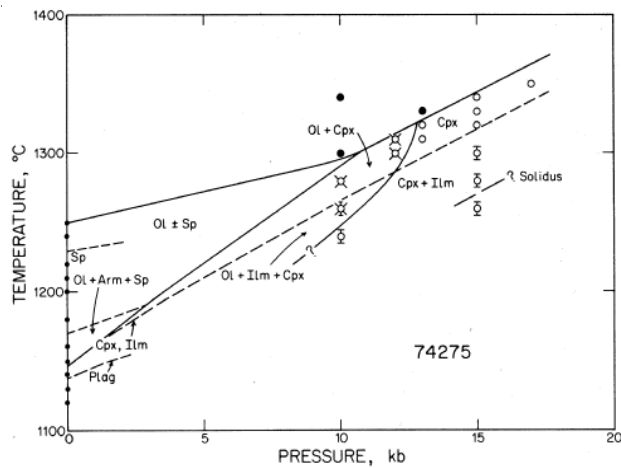

Figure 18: Experimentally determined phase relations as function of pressure for 74275 (from Green et al. 1975).

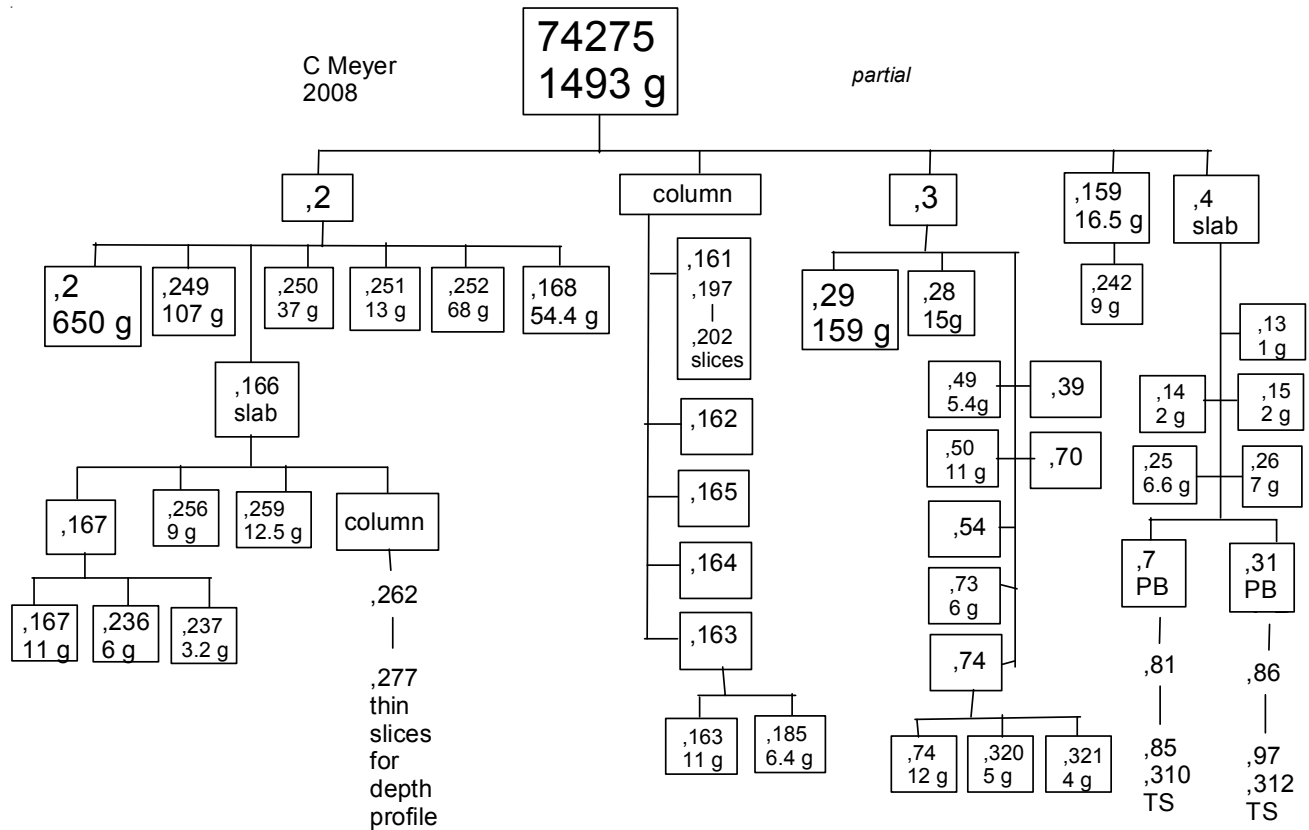

Table 3: Analysis of armalcolite.

| | | | | | | | |
|--------------------------------|--------|--------|--------|-------|--------|------|--------|
| TiO ₂ | 72.9 | 73.5 | 72.8 | 74.2 | 73.6 | 72.8 | 72.7 |
| FeO | 16.6 | 15.5 | 17.5 | 15 | 16.6 | 15.5 | 17.4 |
| MnO | 0.12 | 0.29 | 0.17 | 0.08 | 0.13 | 0.05 | 0.16 |
| MgO | 6.59 | 6.92 | 6.35 | 7.39 | 6.64 | 7 | 6.38 |
| Cr ₂ O ₃ | 1.69 | 2.3 | 1.81 | 2.05 | 2.06 | 2.01 | 1.52 |
| Al ₂ O ₃ | 2.11 | 2.13 | 1.94 | 2.1 | 2.1 | 2.04 | 2.06 |
| total | 100.01 | 100.64 | 100.57 | 100.8 | 101.13 | 99.4 | 100.22 |

Stanin and Taylor (1980).



Figure 19: First partial slab cut from 74275. Position of first column and second slab indicated. NASA# 73-28789. Nice illustration of our 1 cm cube as well as our 1 inch cube!

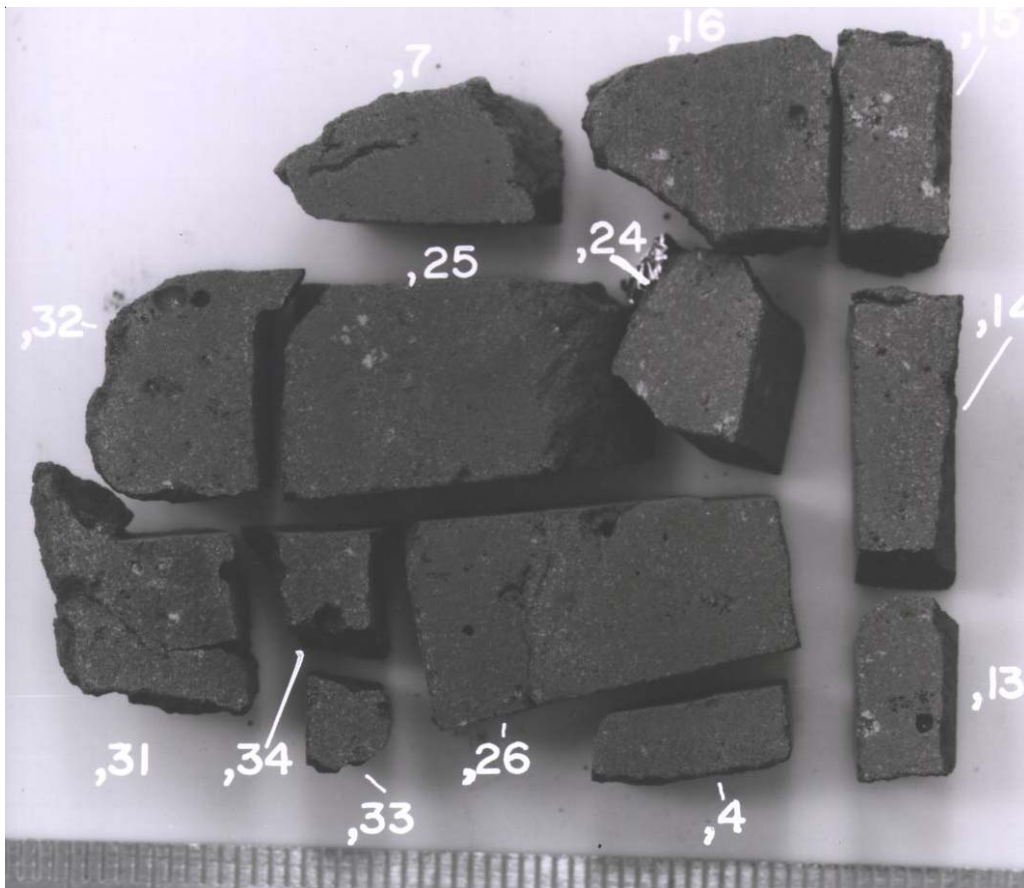

Figure 20: Documentation of first slab (4?). NASA S73-28788

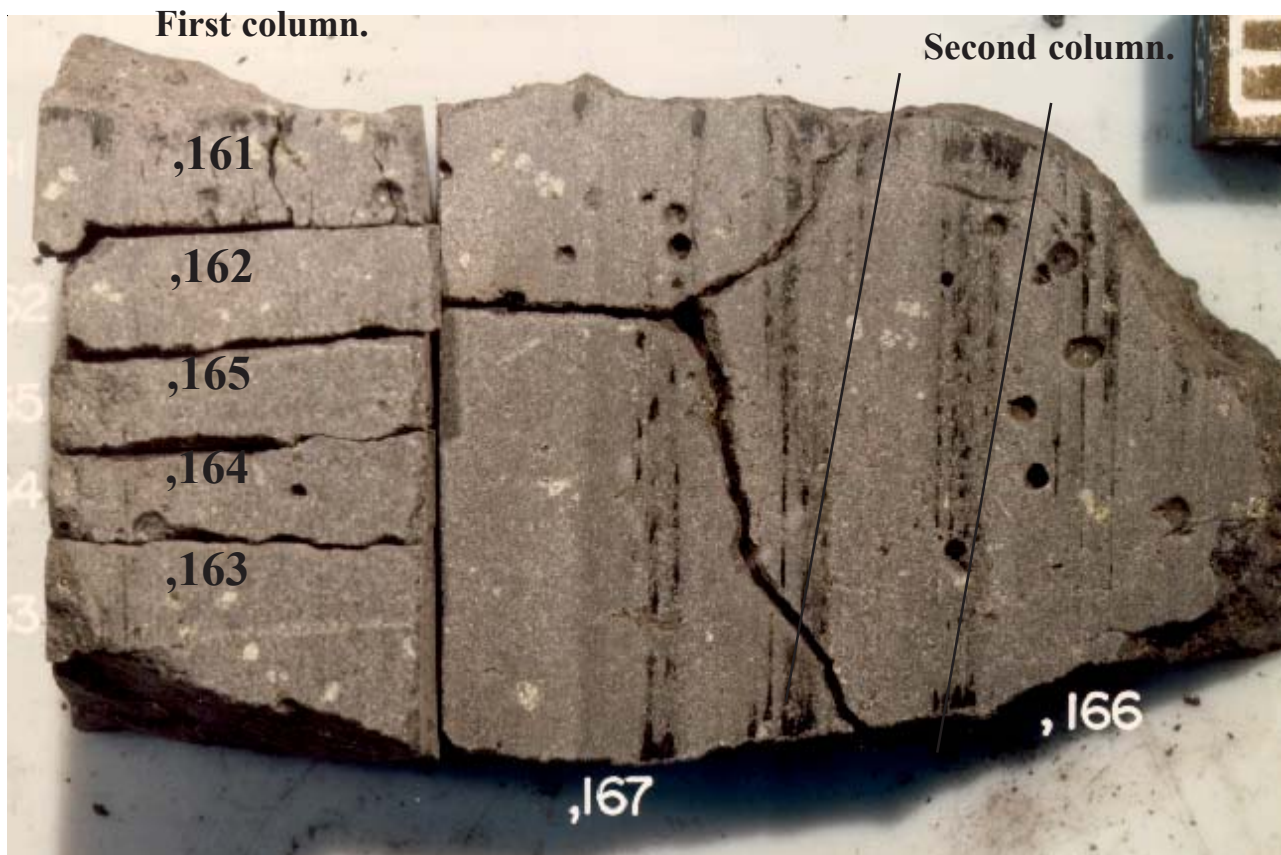

Figure 21: Second slab and first column cut from 74275. Approximate position of second column shown. NASA# S81-34494. Cube is 1 cm.

References for 74275

- Arvidson R., Crozaz G., Drozd R.J., Hohenberg C.M. and Morgan C.J. (1975) Cosmic ray exposure ages of features and events at the Apollo landing sites. *The Moon* **13**, 259-276.
- Arvidson R., Drozd R., Guinness E., Hohenberg C., Morgan C., Morrison R. and Oberbeck V. (1976) Cosmic ray exposure ages of Apollo 17 samples and the age of Tycho. *Proc. 7th Lunar Sci. Conf.* 2817-2832.
- Butler P. (1973) **Lunar Sample Information Catalog Apollo 17**. Lunar Receiving Laboratory. MSC 03211 Curator's Catalog. pp. 447.
- Brecher A., Menke W.H. and Morash K.R. (1974) Comparative magnetic studies of some Apollo 17 rocks and soils and their implications. *Proc. 5th Lunar Sci. Conf.* 2795-2814.
- Brown G.M., Peckett A., Emeleus C.H., Phillips R. and Pinsent R.H. (1975a) Petrology and mineralogy of Apollo 17 mare basalts. *Proc. 6th Lunar Sci. Conf.* 1-13.
- Brunfelt A.O., Heier K.S., Nilssen B., Steinnes E. and Sundvoll B. (1974) Elemental composition of Apollo 17 fines and rocks. *Proc. 5th Lunar Sci. Conf.* 981-990.
- Crozaz G. (1978) Regolith depositional history at Shorty Crater. *Proc. 9th Lunar Planet. Sci. Conf.* 2001-2009.
- Delano J.W. and Lindsley D.H. (1982) Chromium, nickel, and titanium abundances in 74275 olivines: More evidence for a high-pressure origin of high-titanium mare basalts (abs). *Lunar Planet. Sci. XIII*, 160-161. Lunar Planetary Institute, Houston
- Des Marais D.J. (1978a) Carbon, nitrogen and sulfur in Apollo 15, 16 and 17 rocks. *Proc. 9th Lunar Planet. Sci. Conf.* 2451-2467.
- Dickinson T., Taylor G.J., Keil K. and Bild R.W. (1989) Germanium abundances in lunar basalts: Evidence of mantle metasomatism. *Proc. 19th Lunar Planet. Sci.* 189-198. Lunar Planetary Institute, Houston
- Duncan A.R., Erlank A.J., Willis J.P., Sher M.K. and Ahrens L.H. (1974a) Trace element evidence for a two-stage origin of some titaniferous mare basalts. *Proc. 5th Lunar Sci. Conf.* 1147-1157.

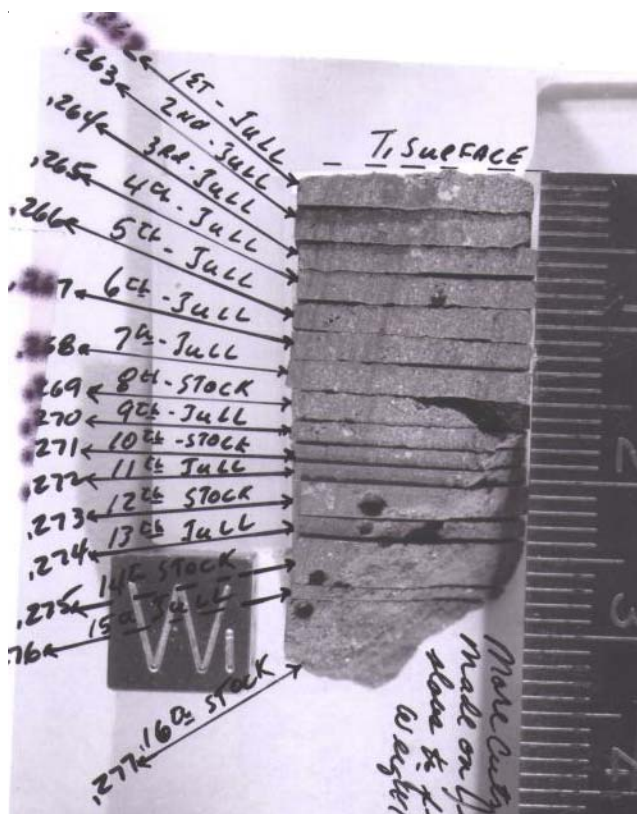

Figure 22: Photo of second column cut from 74275,166. Cube is 1 cm. Processing photo.

Eberhardt P., Eugster O., Geiss J., Graf H., Grögler N., Morgeli M. and Stettler A. (1975a) Kr81-Kr exposure ages of some Apollo 14, Apollo 16 and Apollo 17 rocks (abs). *Lunar Sci.* VI, 233-235. Lunar Planetary Institute, Houston

Eberhardt P., Eugster O., Geiss J., Grögler N., Jungck M., Mauer P., Mörgeli M. and Stettler A. (1975b) Shorty Crater, noble gasses, and chronology (abs). *Meteoritics* 10, 93-94.

El Goresy A., Ramdohr P., Medenbach O. and Bernhardt H.-J. (1974a) Taurus-Littrow TiO₂-rich basalts: Opaque mineralogy and geochemistry. *Proc. 5th Lunar Sci. Conf.* 627-652.

Eugster O., Eberhardt P., Geiss J., Grögler N., Jungck M. and Mörgeli M. (1977) The cosmic-ray exposure history of Shorty Crater samples; the age of Shorty Crater. *Proc. 8th Lunar Sci. Conf.* 3059-3082.

Fink D., Klein J., Middleton R., Vogt S., Herzog G.F. and Reedy R.C. (1998) ⁴¹Ca, ²⁶Al and ¹⁰Be in lunar basalt 74275 and ¹⁰Be in double drive tube 74002/74001. *Geochim. Cosmochim. Acta* 62, 2389-2402.

Fruchter J.S., Evans J.C., Reeves J.H. and Perkins R.W. (1982) Measurement of ²⁶Al in Apollo 15 core 15008 and

²²Na in Apollo 17 rock 74275 (abs). *Lunar Planet. Sci.* XIII, 243-244. Lunar Planetary Institute, Houston

Garg A.N. and Ehmann W.N. (1976a) Zr-Hf fractionation in chemically defined lunar rock groups. *Proc. 7th Lunar Sci. Conf.* 3397-3410.

Gibson E.K. and Moore G.W. (1974a) Sulfur abundances and distributions in the valley of Taurus-Littrow. *Proc. 5th Lunar Sci. Conf.* 1823-1837.

Gibson E.K., Usselman T.M. and Morris R.V. (1976a) Sulfur in the Apollo 17 basalts and their source regions. *Proc. 7th Lunar Sci. Conf.* 1491-1505.

Gibson E.K., Bustin R., Skaugset A., Can R.H., Wentworth S.J. and McKay D.S. (1987) Hydrogen distributions in lunar materials (abs). *Lunar Planet. Sci.* XVIII, 326-327. Lunar Planetary Institute, Houston

Goswami J.N. and Lal D. (1974) Cosmic ray irradiation pattern at the Apollo 17 site: implications to lunar regolith dynamics. *Proc. 5th Lunar Sci. Conf.* 2643-2662.

Green D.H., Ringwood A.E., Ware N.G. and Hibberson W.O. (1974) Petrology and petrogenesis of Apollo 17 basalts and Apollo 17 orange glass (abs). *Lunar Sci.* V, 287-289. Lunar Planetary Institute, Houston

Green D.H., Ringwood A.E., Hibberson W.O. and Ware N.G. (1975a) Experimental petrology of Apollo 17 mare basalts. *Proc. 6th Lunar Sci. Conf.* 871-893.

Green D.H., Ringwood A.E., Ware N.G. and Hibberson W.O. (1975b) Experimental petrology and petrogenesis of Apollo 17 mare basalts (abs). *Lunar Sci.* VI, 311-313. Lunar Planetary Institute, Houston

Hodges F.N. and Kushiro I. (1974a) Apollo 17 petrology and experimental determination of differentiation sequences in model Moon compositions. *Proc. 5th Lunar Sci. Conf.* 505-520.

Hodges F.N. and Kushiro I. (1974b) Apollo 17 petrology and experimental determination of differentiation sequences in model Moon compositions (abs). *Lunar Sci.* V, 340-342.

Hughes S.S. and Schmitt R.A. (1985) Zr-Hf-Ta fractionation during lunar evolution. *Proc. 16th Lunar Planet. Sci. Conf.* in *J. Geophys. Res.* D31-D45.

Hughes S.S. and Schmitt R.A. (1985) Confirmation of Zr-Hf fractionation in lunar petrogenesis - an interim report (abs). *Lunar Planet. Sci.* XV, 385-386. Lunar Planetary Institute, Houston

- Irving A.J., Merrill R.B. and Singleton D.E. (1978) Experimental partitioning of rare earth elements and scandium among armalcolite, olivine, and mare basalt liquids. *Proc. 9th Lunar Planet. Sci. Conf.* 601-612.
- Jovanovic S. and Reed G.W. (1974a) Labile and nonlabile element relationships among Apollo 17 samples. *Proc. 5th Lunar Sci. Conf.* 1685-1701. Lunar Planetary Institute, Houston
- Klein J., Middleton R., Fink D., Dietrich J.W., Aylmer D. and Herzog G.F. (1988) Beryllium- 10 and aluminum-26 contents of lunar rock 74275 (abs). *Lunar Planet. Sci. XIX*, 607-608. Lunar Planet. Institute, Houston.
- LSPET (1973) Apollo 17 lunar samples: Chemical and petrographic description. *Science* **182**, 659-672.
- LSPET (1973) Preliminary Examination of lunar samples. Apollo 17 Preliminary Science Rpt. NASA SP-330. 7-1 – 7-46.
- Meyer C.E. and Wilshire H.G. (1974) “Dunite” inclusion in lunar basal 74275 (abs). *Lunar Sci. V*, 503-505. Lunar Planetary Institute, Houston.
- McGee P.E., Warren J.L. and Simonds C.H. (1977) Introduction to the Apollo Collections: Part I Lunar Igneous Rocks. Curators Office.
- Miller M.D., Pacer R.A., Ma M.-S., Hawke B.R., Lookhart G.L. and Ehmann W.D. (1974) Compositional studies of the lunar regolith at the Apollo 17 site. *Proc. 5th Lunar Sci. Conf.* 1079-1086.
- Mizutani H. and Osako M. (1974a) Elastic-wave velocities and thermal diffusivities of Apollo 17 rocks and their geophysical implications. *Proc. 5th Lunar Sci. Conf.* 2891-2901.
- Mizutani H. and Osako M. (1974b) Elastic wave velocities and thermal diffusivities of Apollo 17 rocks (abs). *Lunar Sci. V*, 518-519. Lunar Planetary Institute, Houston.
- Muehlberger et al. (1973) Documentation and environment of the Apollo 17 samples: A preliminary report. *Astrogeology* 71 322 pp superseded by *Astrogeology* 73 (1975) and by Wolfe et al. (1981)
- Muehlberger W.R. and many others (1973) Preliminary Geological Investigation of the Apollo 17 Landing Site. *In Apollo 17 Preliminary Science Report*. NASA SP-330.
- Murthy V.R. and Coscio C. (1976) Rb-Sr ages and isotopic systematics of some Serenitatis mare basalts. *Proc. 7th Lunar Sci. Conf.* 1529-1544.
- Murthy V.R. and Coscio C. (1977) Rb-Sr isotopic systematics and initial Sr considerations for some lunar samples (abs). *Lunar Sci. VIII*, 706-708. Lunar Planetary Institute, Houston.
- Nagata T., Sugiura N., Fisher R.M., Schwerer F.C., Fuller M.D. and Dunn J.R. (1974b) Magnetic properties and natural remanent magnetization of Apollo 16 and 17 lunar samples (abs). *Lunar Sci. V*, 540-542. Lunar Planetary Institute, Houston
- Nagata T., Fisher R.M., Schwerer F.C., Fuller M.D. and Dunn J.R. (1975a) Effects of meteorite impact on magnetic properties of Apollo lunar materials. *Proc. 6th Lunar Sci. Conf.* 3111-3122.
- Neal C.R. (2001) Interior of the moon: The presence of garnet in the primitive deep lunar mantle. *J. Geophys. Res.* **106**, 27865-27885.
- Neal C.R., Taylor L.A., Patchen A.D., Hughes S.S. and Schmitt R.A. (1990a) The significance of fractional crystallization in the petrogenesis of Apollo 17 Type A and B high-Ti basalts. *Geochim. Cosmochim. Acta* **54**, 1817-1833.
- Neal C.R. and Taylor L.A. (1993) Catalog of Apollo 17 rocks. Vol. 3 Central Valley. Curators Office LBJSC. Houston
- Nunes P.D., Tatsumoto M. and Unruh D.M. (1974b) U-Th-Pb systematics of some Apollo 17 lunar samples and implications for a lunar basin excavation chronology. *Proc. 5th Lunar Sci. Conf.* 1487-1514.
- Nunes P.D., Tasumoto M. and Unruh D.M. (1974c) U-Th-Pb systematics of some Apollo 17 samples (abs). *Lunar Sci. V*, 562-564. Lunar Planetary Institute, Houston
- Nyquist L.E. (1977) Lunar Rb-Sr chronology. *Phys. Chem. Earth* **10**, 103-142.
- Nyquist L.E., Bansal B.M. and Wiesmann H. (1976a) Sr isotopic constraints on the petrogenesis of Apollo 17 mare basalts. *Proc. 7th Lunar Sci. Conf.* 1507-1528.
- Nyquist L.E., Bansal B.M. and Wiesmann H. (1976b) Sr isotopic constraints on the petrogenesis of Apollo 17 mare basalts (abs). *Lunar Sci. VII*, 636-638. Lunar Planetary Institute, Houston
- O’Hara M.J., Biggar G.M., Hill P.G., Jefferies B. and Humphries D.J. (1974) Plagioclase saturation in lunar high-Titanium basalt. *Earth Planet. Sci. Lett.* **21**, 253-268.
- O’Hara M.J., Biggar G.M., Humphries D.J. and Saha P. (1974b) Experimental petrology of high titanium basalt

- (abs). *Lunar Sci.* V, 571-573. Lunar Planetary Institute, Houston
- O'Hara M.J. and Humphries D.J. (1975) Armalcolite crystallization, phenocryst assemblages, eruption conditions and origin of eleven high titanium basalts from Taurus Littrow (abs). *Lunar Sci.* VI, 619-621. Lunar Planetary Institute, Houston.
- O'Hara M.J. and Humphries D.J. (1977) Gravitational separation of quenching crystals: a cause of chemical differentiation in lunar basalts. *Phil. Trans. Roy. Soc. London* **A285**, 177-192.
- Paces J.B., Nakai S., Neal C.R., Taylor L.A., Halliday A.N. and Lee D.-C. (1991) A strontium and neodymium isotopic study of Apollo 17 high-Ti mare basalts: Resolution of ages, evolution of magmas, and origin of source heterogeneities. *Geochim. Cosmochim. Acta* **55**, 2025-2043.
- Pearce G.W., Strangway D.W. and Gose W.A. (1974a) Magnetic properties of Apollo samples and implications for regolith formation. *Proc. 5th Lunar Sci. Conf.* 2815-2826.
- Pearce G.W., Gose W.A. and Strangway D.W. (1974b) Magnetism of the Apollo 17 samples (abs). *Lunar Sci.* V, 590-592. Lunar Planetary Institute, Houston
- Petrowski C., Kerridge J.F. and Kaplan I.R. (1974) Light element geochemistry of the Apollo 17 site. *Proc. 5th Lunar Sci. Conf.* 1939-1948.
- Rees C.E. and Thode H.G. (1974a) Sulfur concentrations and isotope ratios in Apollo 16 and 17 samples. *Proc. 5th Lunar Sci. Conf.* 1963-1973.
- Rees C.E. and Thode H.G. (1974b) Sulfur concentrations and isotope ratios in Apollo 16 and 17 samples (abs). *Lunar Sci.* V, 621-623. Lunar Planetary Institute, Houston
- Rhodes J.M., Hubbard N.J., Wiesmann H., Rodgers K.V., Brannon J.C. and Bansal B.M. (1976a) Chemistry, classification, and petrogenesis of Apollo 17 mare basalts. *Proc. 7th Lunar Sci. Conf.* 1467-1489.
- Rhodes J.M., Hubbard N.J., Wiesmann H., Rodgers K.V. and Bansal B.M. (1976b) Chemistry, classification and petrogenesis of Apollo 17 mare basalts (abs). *Lunar Sci.* VII, 730-732. Lunar Planetary Institute, Houston
- Rose H.J., Baedeker P.A., Berman S., Christian R.P., Dwornik E.J., Finkelman R.B. and Schnepfe M.M. (1975a) Chemical composition of rocks and soils returned by the Apollo 15, 16, and 17 missions. *Proc. 6th Lunar Sci. Conf.* 1363-1373.
- Rose H.J., Christian R.P., Dwornik E.J. and Schnepfe M.M. (1975b) Major elemental analysis of some Apollo 15, 16, and 17 samples (abs). *Lunar Sci.* VI, 686-688. Lunar Planetary Institute, Houston
- Stanin F.T. and Taylor L.A. (1979a) Armalcolite/ilmenite: Mineral chemistry, paragenesis, and origin of textures. *Proc. 10th Lunar Planet. Sci. Conf.* 383-405.
- Stanin F.T. and Taylor L.A. (1979b) Ilmenite/armalcolite: Effects of rock composition, oxygen fugacity, and cooling rate (abs). *Lunar Planet. Sci.* X, 1160-1162. Lunar Planetary Institute, Houston
- Stanin F.T. and Taylor L.A. (1980a) Armalcolite: an oxygen fugacity indicator. *Proc. 11th Lunar Planet. Sci. Conf.* 117-124.
- Stanin F.T. and Taylor L.A. (1980b) An oxygen geobarometer for lunar high-titanium basalts (abs). *Lunar Planet. Sci.* XI, 1079-1081. Lunar Planetary Institute, Houston
- Schnabel C., Xue S., Ma P., Herzog G.F., Figfield K., Cresswell R.G., Tada M.L., Hauslaned P. and Reedy R.C. (2000) Nickel-59 in surface layers of lunar basalt 74275: Implications for the solar alpha particle flux (abs#1778). *Lunar Planet. Sci.* XXXI, Lunar Planetary Institute, Houston.
- Sisterson J.M and Reedy R.C. (1997) Revised estimates for SCR-produced ²²Na in lunar rock 74275 using new cross section measurements (abs). *Lunar Planet. Sci.* XVIII. Lunar Planet. Institute, Houston.
- Sung C.-M., Abu-Eid R.M. and Burns R.G. (1974a) Ti³⁺/Ti⁴⁺ ratios in lunar pyroxenes: implications to depth of origin of mare basalt magma. *Proc. 5th Lunar Sci. Conf.* 717-726.
- Sung C.-M., Abu-Eid R.M. and Burns R.G. (1974b) A search for trivalent titanium in Apollo 17 pyroxenes (abs). *Lunar Sci.* V, 758-760. Lunar Planetary Institute, Houston
- Usselman T.M. and Lofgren G.E. (1976a) The phase relations, textures, and mineral chemistries of high-titanium mare basalts as a function of oxygen fugacity and cooling rate. *Proc. 7th Lunar Sci. Conf.* 1345-1363.
- Usselman T.M. and Lofgren G.E. (1976b) Phase relations of high-titanium mare basalts as a function of oxygen fugacity (abs). *Lunar Sci.* VII, 888-890. Lunar Planetary Institute, Houston
- Usselman T.M., Lofgren G.E., Donaldson C.H. and Williams R.J. (1975) Experimentally reproduced textures and mineral chemistries of high-titanium mare basalts. *Proc. 6th Lunar Sci. Conf.* 997-1020.

Walker D., Longhi J. and Hays J.F. (1975a) Heterogeneity in titaniferous lunar basalts. In Conference on **Origins of Mare Basalts** and their Implications for Lunar Evolution, 169-173. Lunar Science Institute, Houston

Walker D., Longhi J., Stolper E.M., Grove T.L. and Hays J.F. (1975b) Origin of titaniferous lunar basalts. *Geochim. Cosmochim. Acta* **39**, 1219-1235.

Walker D., Longhi J. and Hays J.F. (1976a) Heterogeneity in titaniferous lunar basalts. *Earth Planet. Sci. Lett.* **30**, 27-36.

Wänke H., Palme H., Baddenhausen H., Dreibus G., Jagoutz E., Kruse H., Spettel B., Teschke F. and Thacker R. (1974) Chemistry of Apollo 16 and 17 samples: bulk composition, late-stage accumulation and early differentiation of the Moon. *Proc. 5th Lunar Sci. Conf.* 1307-1335.

Wolfe E.W., Bailey N.G., Lucchitta B.K., Muehlberger W.R., Scott D.H., Sutton R.L and Wilshire H.G. (1981) The geologic investigation of the Taurus-Littrow Valley: Apollo 17 Landing Site. US Geol. Survey Prof. Paper, 1080, pp. 280.