

78535 – 103.4 grams

78536 – 8.67 grams

78537 – 11.76 grams

78538 - 5.82 grams

78539 – 3.73 grams

78545 – 8.6 grams

78568 – 3.6 grams

Speckled Regolith Breccia



Figure 1: Photo of 78535. Cube is 1 cm. S73-21390

Introduction

78535 and related samples are coherent regolith breccias with numerous small plagioclase inclusions set in a dark brown (glassy) matrix.

See also section on 78546, which was well studied by Simon et al. (1990) and seems to be the same type of breccia.

Petrography

Butler (1973), Keil et al. (1974), Warner et al (1978) and Meyer (1994) briefly describe 78535 in their catalogs. “The breccia matrix consists of abundant small mineral clasts together with dark brown glass that firmly cements the rock. Porosity is low. There are small clasts of mare basalt, breccias of various type, glass with various color and numerous mineral clasts.”

78568 has a thin white coating on one side (figure 9), but is otherwise similar to 78535 it also has a large

white clast, possibly shocked anorthosite (Meyer 1994)..

Warner et al. (1979) reported glass analyses for 78535, and other rocks.

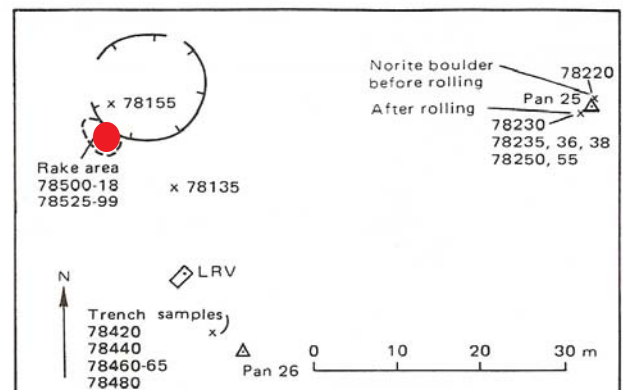

Figure 2: Map of station 8, Apollo A17.



Figure 3a: Closeup of 78535 showing classic speckled lithology of dark matrix regolith breccias found on North Massif. S73-32349.

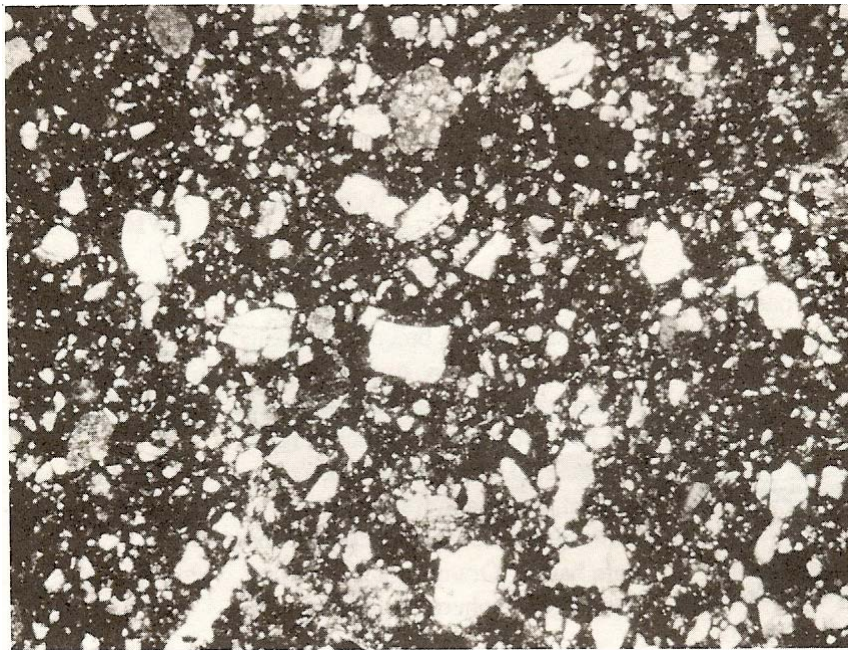

Figure 3b: Photomicrograph of thin section of 78535,7. Field of view is 3 x 4 mm.



Figure 4: Photo of 78536. Scale in mm. S73-33419

Chemistry

The chemical analysis of 78535 by Laul and Schmitt (1975) seems to be more aluminous than 78546, which otherwise seems similar (figure 10), but the REE analyses are similar to the local soil (figure 11).

Processing

There are a couple thin sections each for 78535, 78537 and 78568.



Figure 5a: Photo of 78537. Scale in mm. S73-21009

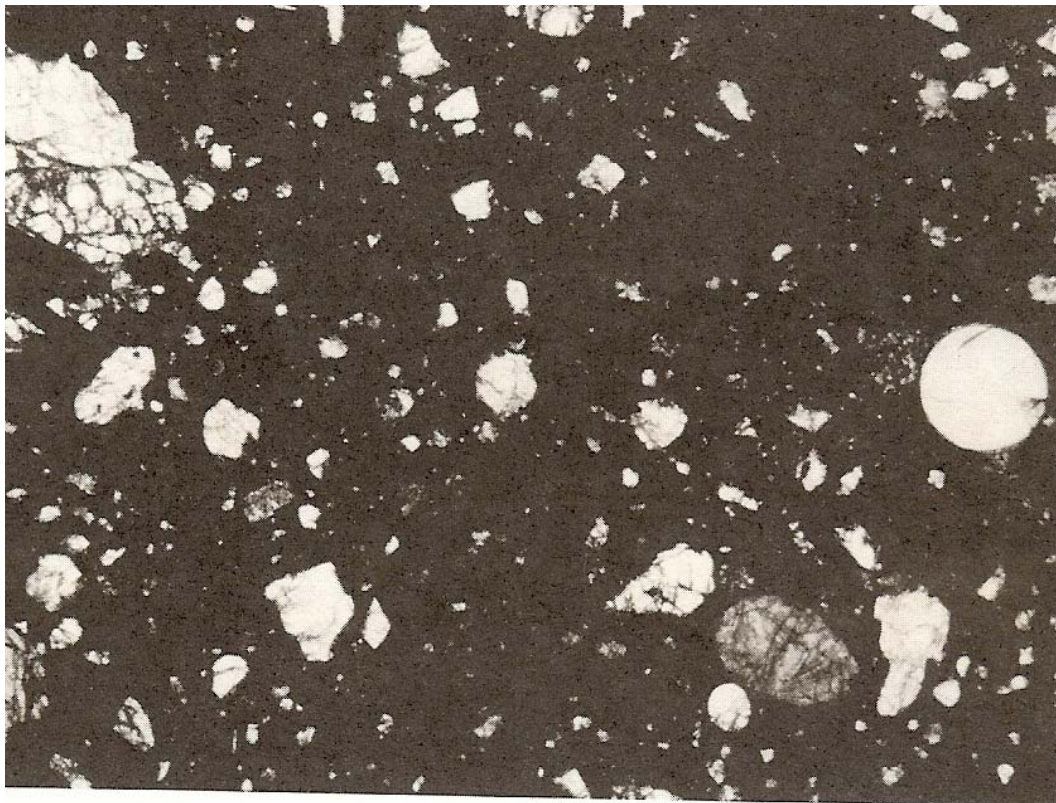

Figure 5b: Photomicrograph of thin section 78537,17. Field of view is 3 x 4 mm.

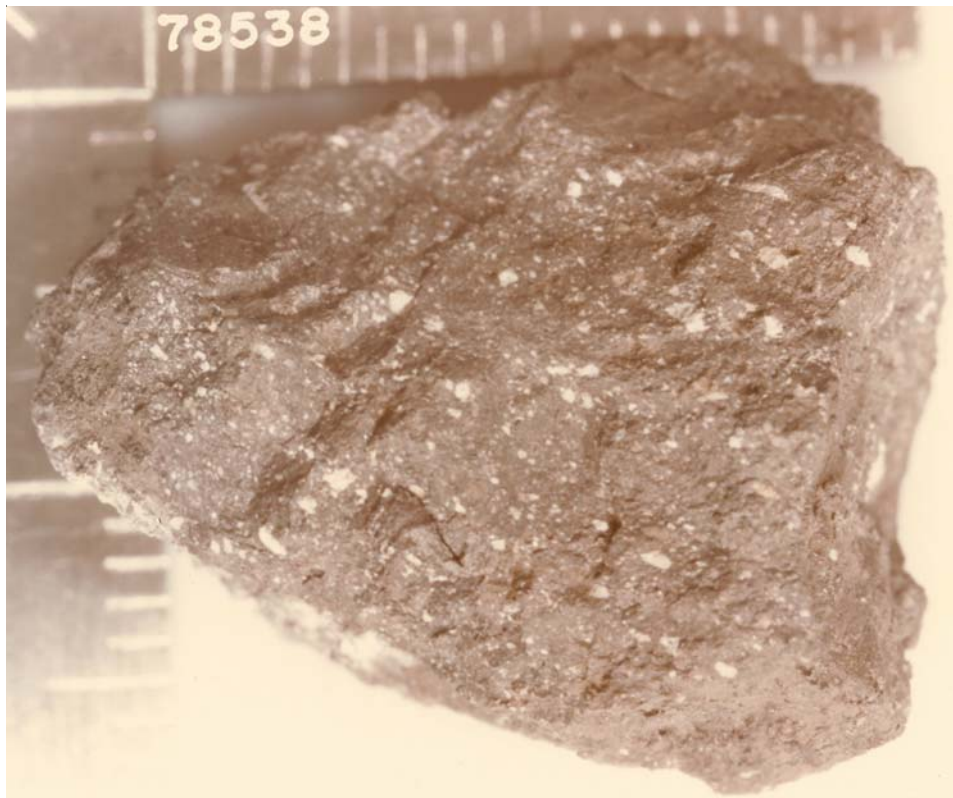

Figure 6: Photo of 78538. Scale in mm. S73-33411



Figure 7: Photo of 78539. Scale in mm. S73-21018



Figure 8: Photo of 78545. Scale in mm and cm. S73-33398

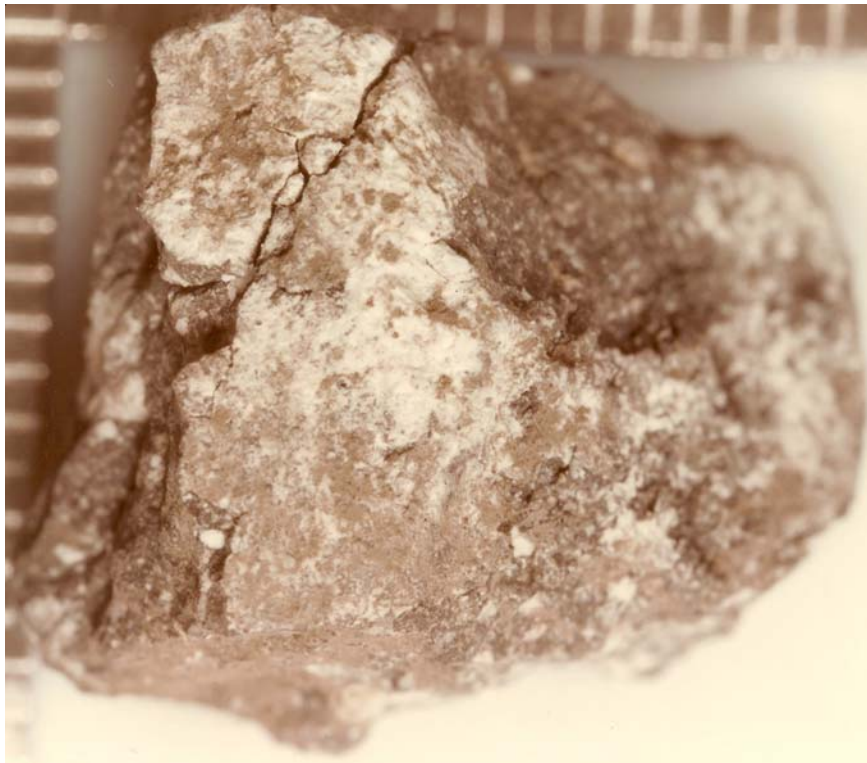

Figure 9. Photo of 78568. Scale in mm. S73-33413.

Table 1. Chemical composition of 78535.

78535		
reference	Laul75	
<i>weight</i>		
SiO ₂ %		
TiO ₂	3.9	(a)
Al ₂ O ₃	17.2	(a)
FeO	11.3	(a)
MnO	0.14	(a)
MgO	9.7	(a)
CaO	11.6	(a)
Na ₂ O	0.38	(a)
K ₂ O	0.09	(a)
P ₂ O ₅		
S %		
<i>sum</i>		
Sc ppm	32	(a)
V	70	(a)
Cr	2053	(a)
Co	30.7	(a)
Ni	200	(a)
Cu		
Zn		
Ga		
Ge ppb		
As		
Se		
Rb		
Sr		
Y		
Zr		
Nb		
Mo		
Ru		
Rh		
Pd ppb		
Ag ppb		
Cd ppb		
In ppb		
Sn ppb		
Sb ppb		
Te ppb		
Cs ppm		
Ba		
La	8.3	(a)
Ce	24	(a)
Pr		
Nd		
Sm	5.9	(a)
Eu	1.2	(a)
Gd		
Tb	1.2	(a)
Dy	7.2	(a)
Ho		
Er		
Tm		
Yb	4.7	(a)
Lu	0.72	(a)
Hf	4.4	(a)
Ta	0.75	(a)
W ppb		
Re ppb		
Os ppb		
Ir ppb		
Pt ppb		
Au ppb		
Th ppm	1	(a)
U ppm		
<i>technique: (a) INAA</i>		

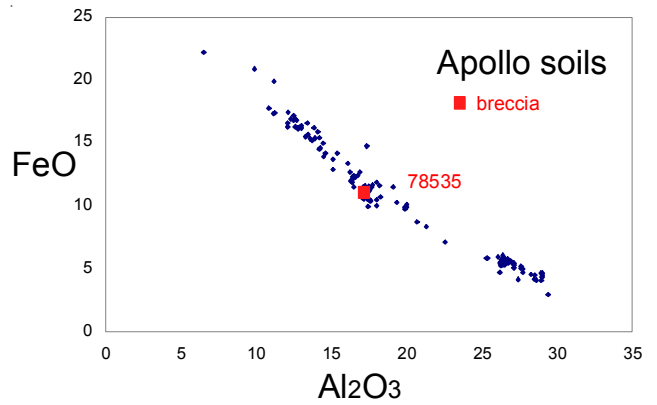

Figure 10: Composition of 78535, compared with lunar soils.

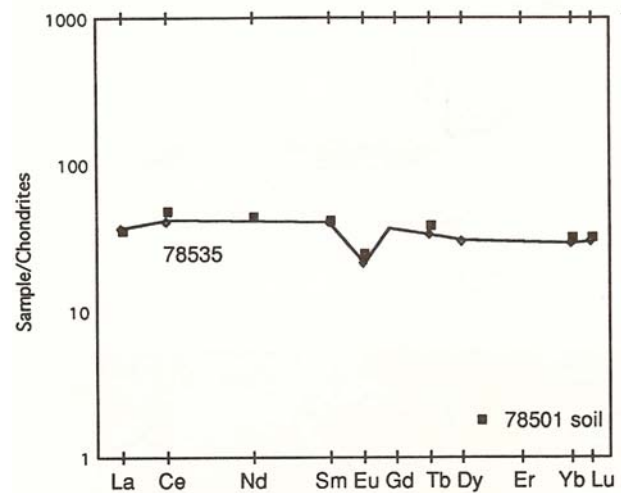
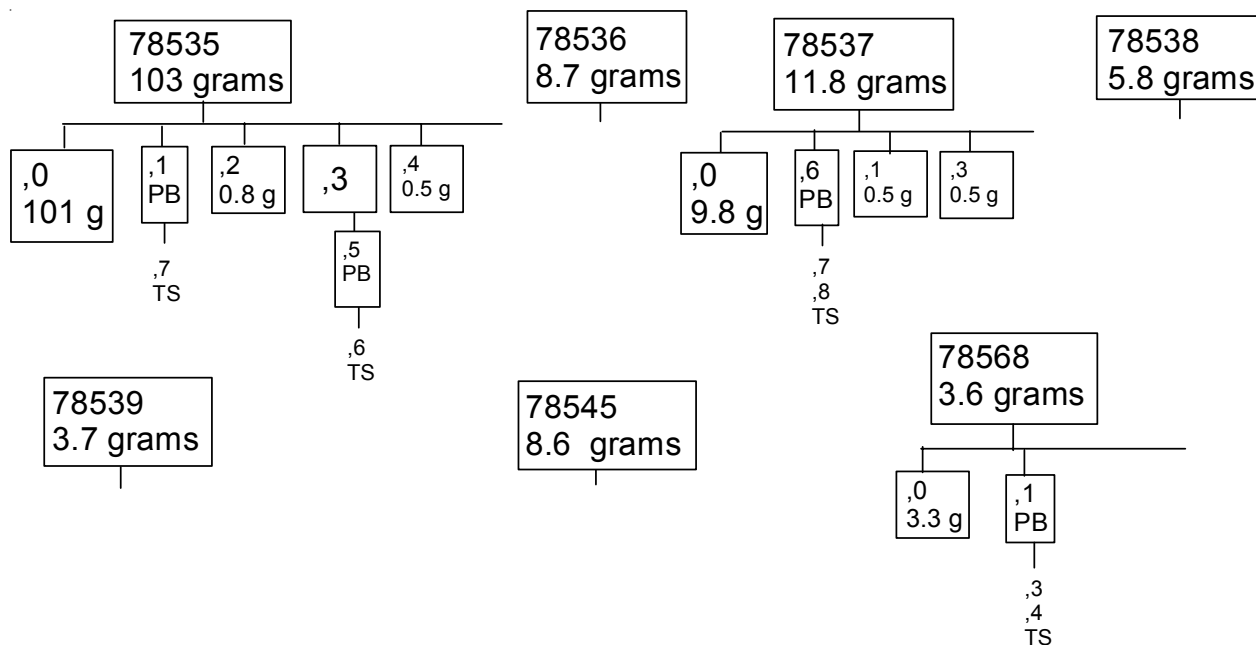

Figure 11: Normalized rare-earth-element diagram for 78535.



References for 78535 and related samples

Butler P. (1973) Lunar Sample Information Catalog Apollo 17. Lunar Receiving Laboratory. MSC 03211 Curator's Catalog. pp. 447.

Keil K., Dowty E. and Prinz M. (1974) Description, classification and inventory of 113 Apollo 17 rake samples from stations 1A, 2, 7 and 8. Curator's Catalog, pp. 149.

Laul J.C. and Schmitt R.A. (1975c) Chemical composition of Apollo 17 samples: Boulder breccias (2), rake breccias (8), and others (abs). *Lunar Sci.* VI, 489-491. Lunar Planetary Institute, Houston.

LSPET (1973) Apollo 17 lunar samples: Chemical and petrographic description. *Science* 182, 659-672.

LSPET (1973) Preliminary Examination of lunar samples. Apollo 17 Preliminary Science Rpt. NASA SP-330. 7-1 – 7-46.

Meyer C. (1994) **Catalog of Apollo 17 rocks**: Volume 4. Curator's Office JSC 26088 pp. 644 76 78

Simon S.B., Papike J.J., Gosselin D.C., Laul J.C., Hughes S.S. and Schmitt R.A. (1990) Petrology and chemistry of Apollo 17 regolith breccias: A history of mixing of highland and mare regolith. *Proc. 20th Lunar Planet. Sci.* 219-230. Lunar Planetary Institute, Houston.

Warner R.D., Keil K., Nehru C.E. and Taylor G.J. (1978) Catalogue of Apollo 17 rake samples from Stations 1a, 2, 7, and 8. Spec. Publ. #18, UNM Institute of Meteoritics, Albuquerque. 88 pp.

Warner R.D., Taylor G.J. and Keil K. (1979c) Composition of glasses in Apollo 17 soil breccias (abs). *Lunar Planet. Sci.* X, 1298-1300. Lunar Planetary Institute, Houston.

Warner R.D., Taylor G.J., Wentworth S.J., Huss G.R., Mansker W.L., Planner H.N., Sayeed U.A. and Keil K. (1979d) Electron microprobe analyses of glasses from Apollo 17 rake sample breccias and Apollo 17 drill core. UNM Spec. Publ. #20, Albuquerque, 20 pp.

Wolfe E.W., Bailey N.G., Lucchitta B.K., Muehlberger W.R., Scott D.H., Sutton R.L and Wilshire H.G. (1981) The geologic investigation of the Taurus-Littrow Valley: Apollo 17 Landing Site. US Geol. Survey Prof. Paper, 1080, pp. 280.